



2026

ITOP Café — Ваш надёжный партнёр в кофейном бизнесе
ITOP Café — 您咖啡事业的可靠伙伴





KOL 见证 Influencer Testimonials

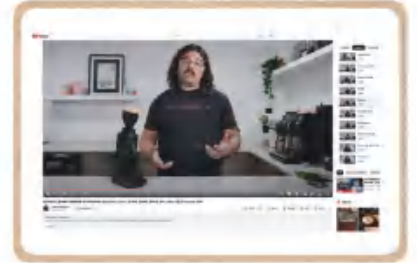
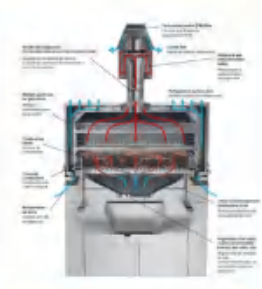



与客户在一起 We are with our customers



山海赴征程
the path we've traveled



目录

关于我们 最新发布

About Us | Latest Releases



关于我们

About Us

01~04

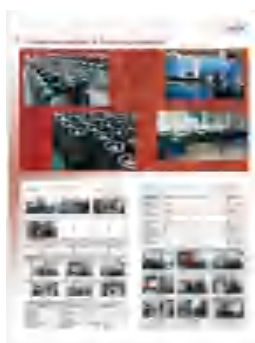

最新发布

Latest Release

05~20

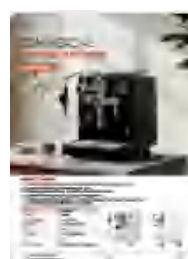
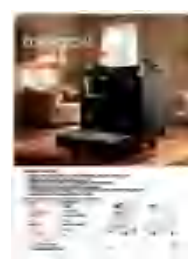
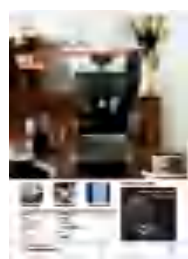
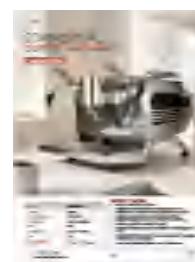
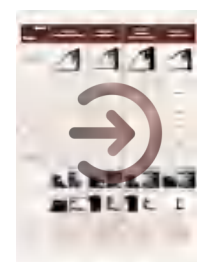



目录

商用咖啡厅 办公咖啡角

Commercial Coffee Shop | Office Coffee Corner

星巴克系列

21~45

Starbucks series

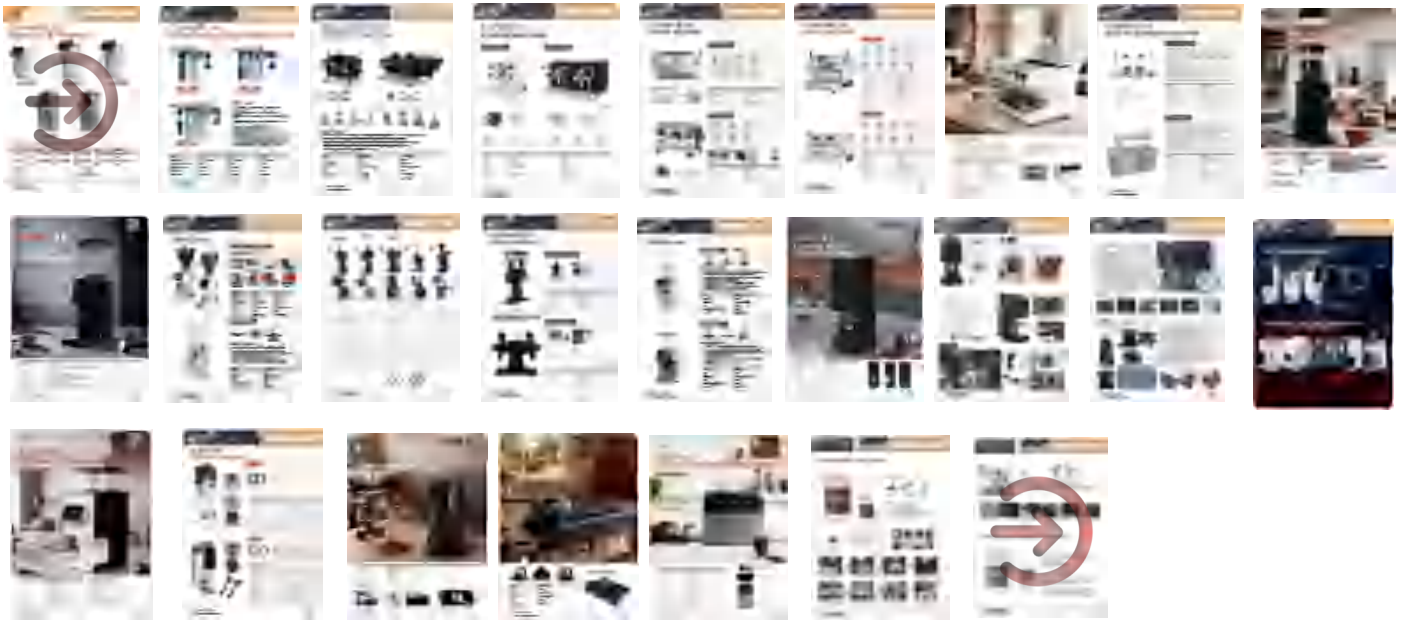

办公室咖啡角系列

46~57

Office Coffee Corner Series



目录



咖啡发烧友系列

Coffee Enthusiast Series

咖啡发烧友系列

Coffee Enthusiast Series

58~102

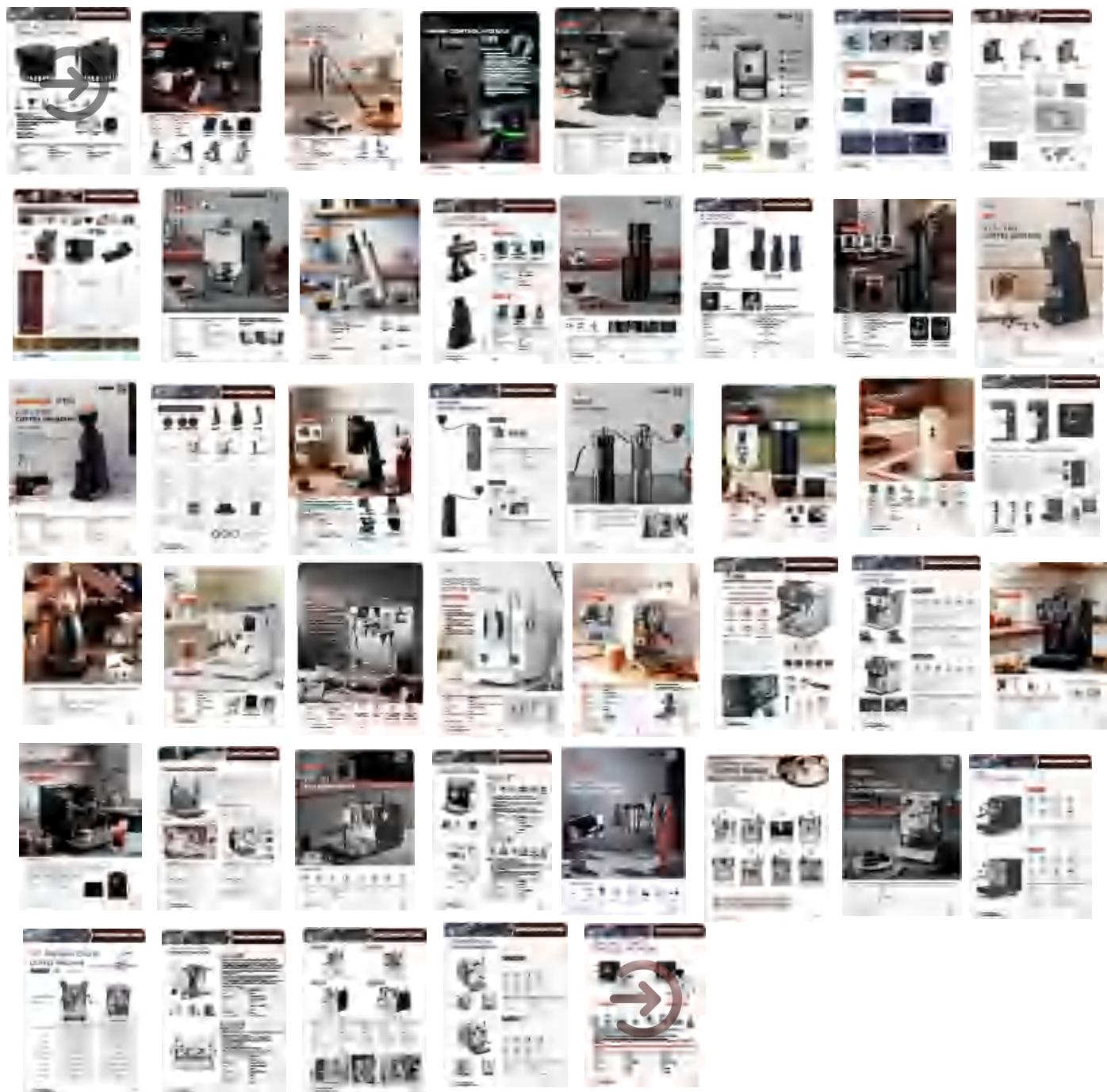



目录

咖啡厅入门系列 咖啡器具

Coffee Shop Beginner Series | Coffee equipment series

咖啡厅入门系列 ----- 103~117

Coffee Shop Beginner Series



咖啡器具系列 ----- 118~136

Coffee equipment series



Our Key Client

We are the the supplier for leading hardware brands, suchas:



In USA



In Poland

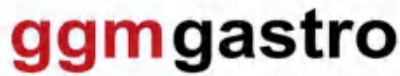

In Germany



In Dubai

ITOP Team

RD Department
Resourcing Department
Export Department

Administration Department
QC Department
Finance Department



2022 New Year's Eve



Milan Exhibition in 2015



Our Customers



Shanghai Exhibition in 2021



Awarded from Alibaba

Company Introduction

We are a group company with 12 years of history, dedicated to export trade. We have two professional teams, one responsible for ITOP catering equipment and the other for ITOP coffee equipment. We use an organizational chart to manage our teams and provide customized services based on our customers' needs, including country market sales and exclusive models. We are committed to meeting our customers' requirements and providing professional technical support and high-quality after-sales service. Our goal is to become a trusted long-term partner of our customers and create more business value together.

我们公司是一家拥有12年历史的集团公司，致力于出口贸易。我们有两个专业团队，一个负责ITOP餐饮设备，另一个负责ITOP咖啡设备。我们采用组织架构图的形式来管理我们的团队，并根据客户的需求，提供包销国家市场和定制化的服务。我们非常注重客户的需求和满意度，为客户提供专业的技术支持和优质的售后服务。我们的目标是成为客户信赖的长期合作伙伴，一起创造更多商业价值。



Our exhibition



Our workshop

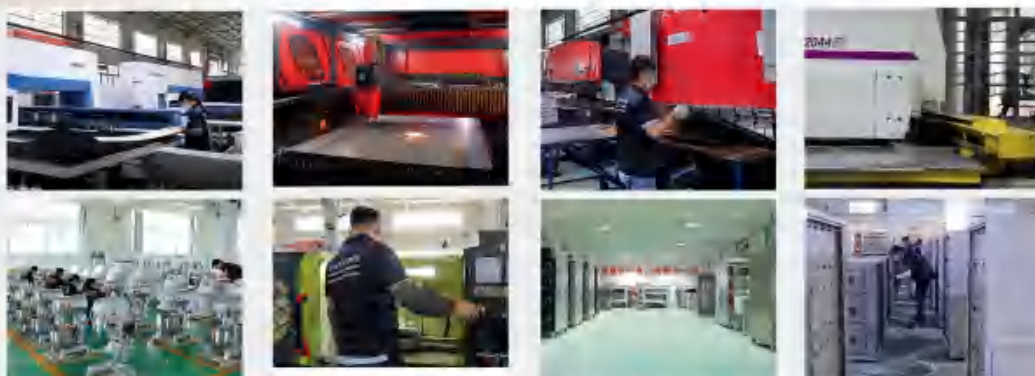

Certificate



Application for SGS
Inspection for VIP Orders

Production workshop & Processing equipment



Overview of the production workshop and processing equipment. The image shows a large industrial facility with various machines and workers. A table lists the equipment details, and two smaller images show specific machines in operation.

Brand & Model No.	Quantity	Number of Year(s) Used	Condition
ACL	20	3.0	Acceptable
DNE 1530	4	3.0	Acceptable
Machine Yawei	3	3.0	Acceptable
ZHIFULAI	11	3.0	Acceptable
Machine N/A	20	3.0	Acceptable
XIANCHAO	3	3.0	Acceptable
Machine DNK-40A	20	3.0	Acceptable
Machine NBV-270A	10	3.0	Acceptable
Forging Pressing Machine ZHUJIANG	3	3.0	Acceptable
Grinding Machine N/A	10	3.0	Acceptable
Foaming Machine N/A	2	3.0	Acceptable
Water Grinding Machine N/A	3	3.0	Acceptable
CNC Machining Center BADUJI	1	1.0	Acceptable

Verified Alibaba.com Gold Plus Supplier
Main Product Lines Verification
Report No.: 22099777_P+T

		
CNC Machining Center	N/A	N/A
		
N/A	N/A	N/A

1.5 Testing Machinery

Machine Name	Brand & Model No.	Quantity	Number of Year(s) Used	Condition
N/A	N/A	N/A	N/A	N/A
N/A	N/A	N/A	N/A	N/A
N/A	N/A	N/A	N/A	N/A

1.6 Production Flow

No.	Production Process	No.	Production Process	No.	Production Process
1		2		3	
4		5		6	
	Welding		Assembly and Inspection		Packing

1.7 Export Market Distribution (Previous Year)

Market	Revenue (USD)	Total Revenue (%)
North America	Confidential	25
South America	Confidential	5
Eastern Europe	Confidential	5
Southeast Asia	Confidential	5

Report No.: 22099777_P+T | Report Date: 02/04/2021 | Assessed By: Victor Du | Victor Du
CONFIDENTIAL | All Rights Reserved | Page No.: 7 of 8

Verified Alibaba.com Gold Plus Supplier
Main Product Lines Verification
Report No.: 22099777_P+T

		
Bending Machine	Punch Pressing Machine	Drilling Machine
		
Spot Welding Machine	Argon Arc Welding Machine	Forging Pressing Machine
		
Grinding Machine	Foaming Machine	Water Grinding Machine

Machine Name	Brand & Model No.	Quantity	Number of Year(s) Used	Condition
Bending Machine	ZHIFULAI	11	3	Acceptable
Punch Pressing Machine	N/A	20	3	Acceptable
Drilling Machine	XIANCHAO	3	3	Acceptable
Spot Welding Machine	DNK-40A	20	3	Acceptable
Argon Arc Welding Machine	NBV-270A	10	3	Acceptable
Forging Pressing Machine	ZHUJIANG	3	3	Acceptable
Grinding Machine	N/A	10	3	Acceptable
Foaming Machine	N/A	2	3	Acceptable
Water Grinding Machine	N/A	3	3	Acceptable
CNC Machining Center	BADUJI	1	1	Acceptable

Report No.: 22099777_P+T | Report Date: 02/04/2021 | Assessed By: Victor Du | Victor Du
CONFIDENTIAL | All Rights Reserved | Page No.: 6 of 8

ITOP 3D scene - Cafe

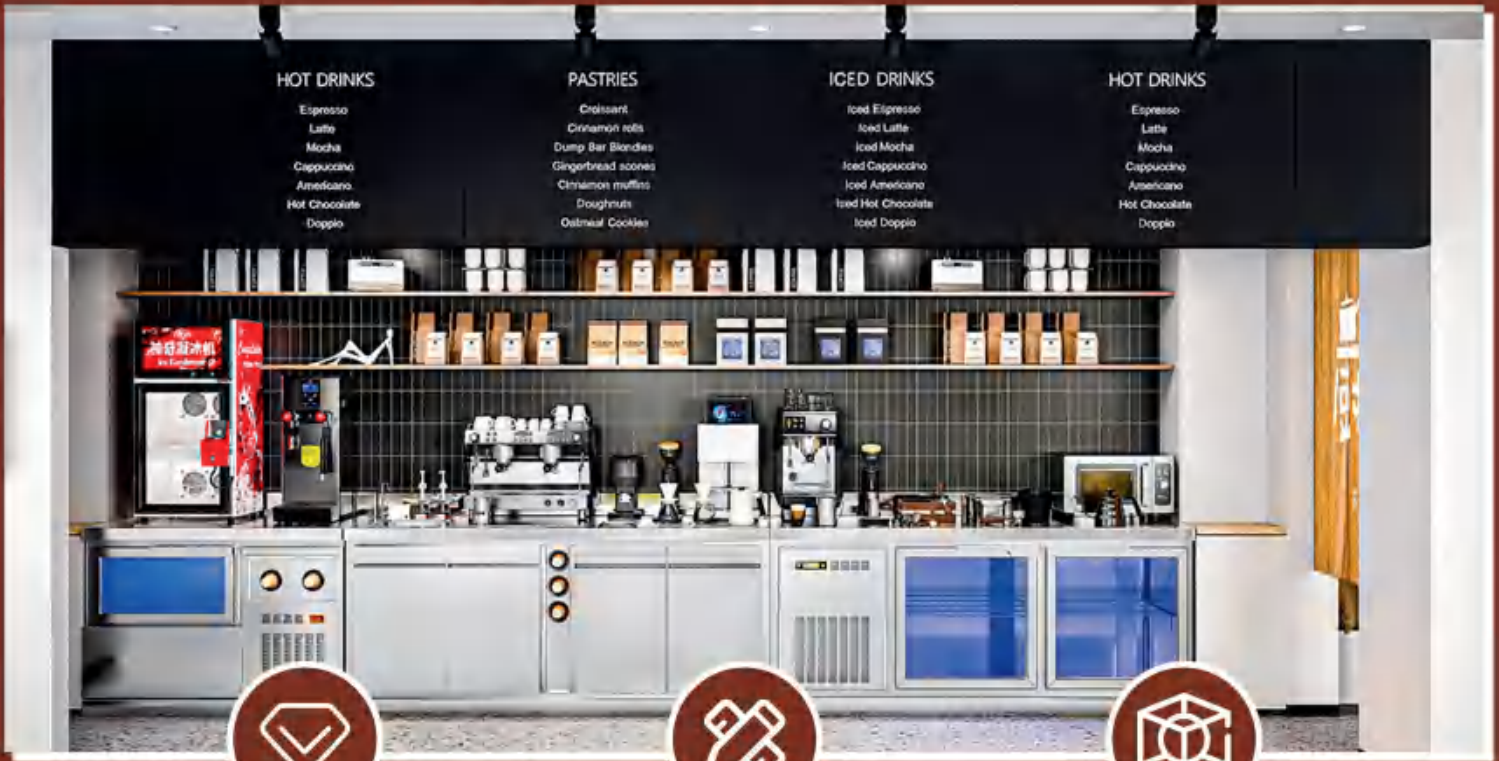

VIP EXCLUSIVE



PRIVATE CUSTOMIZATION





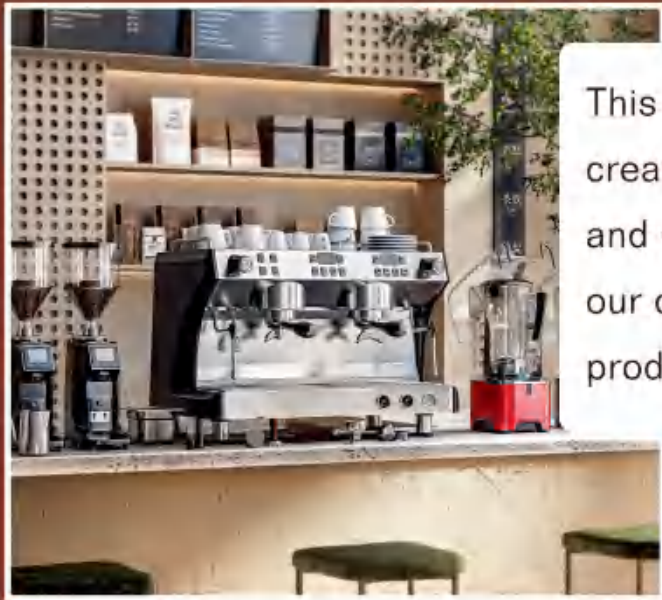







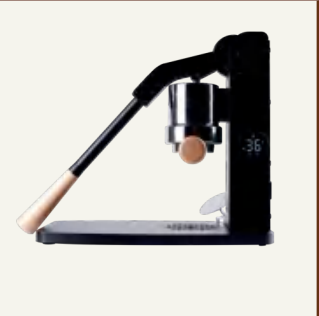

3D MODELING

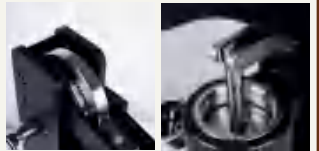

This is a 3D modeling image that our team has created for VIP clients, showcasing various scenes and examples. It serves as a convenient tool for our clients to enhance their marketing and product presentation.



Model Feature	CMFL001 Professional Edition	CMFL002P Heated Model	CMFL002 Constant Temperature Model	CMFL003 Basic Model
Appearance				
Heating Function	Boil Cold Water Directly + Keep Warm	Boil Cold Water Directly + Keep Warm	Preheat Brewing Head	—
Temperature control	Adjustment range 30-100°C	Adjustable range 35-95°C	Adjustable range 35-95°C	—
Brewing Head Capacity	80ml	80ml	120ml	80ml
Heating Time	3-5 Minutes	3-5 Minutes	15 Minutes	—
Materials and Craftsmanship	Anodized aluminum alloy + 316 stainless steel	Anodized aluminum alloy + 316 stainless steel	Anodized aluminum alloy + 316 stainless steel	Anodized aluminum alloy + 316 stainless steel
Core Features	 <p>Planetary reduction gear set Vertical pressure</p>  <p>Precise temperature control Reasonable structural design</p>	 <p>Planetary reduction gear set Vertical pressure</p>  <p>Precise temperature control Reasonable structural design</p>	 <p>Planetary reduction gear set Vertical pressure</p>  <p>Precise temperature control Reasonable structural design</p>	 <p>Planetary reduction gear set Vertical pressure</p>  <p>Reasonable structural design</p>
User groups/ scenarios	Coffee lovers, coffee shops, pour-over coffee studios, and serious users who demand precise extraction and temperature control.	Coffee shops, everyday home use, small venues requiring rapid heating, light coffee drinkers or beginners, and commercial settings that frequently receive guests.	High-end home users, small boutique coffee shops, and professional users with high requirements for temperature stability	Student dormitories, travel carry, entry-level users on a limited budget, temporary events or outdoor use

HAND-PRESSED HEATED COFFEE MAKER

CMFL002P



PRODUCT FEATURE

- Vertical piston pressure application
- Planetary gear reducer, with greater torque
- 200W heating pack, PID temperature control, supports dry burning
- All aluminum alloy shell
- Touch screen temperature control, knob to adjust temperature and set off time

Model	CMFL002P
Dimension	460*200*330mm
N.W.	7KG
Packing size	480*320*440mm
G.W.	9.55KG



Drip tray



Pressure gauge



Brew group



HAND PRESSED COFFEE MACHINE

CMFL002



Model	CMFL002
PID Power	45W
Dimension	205*470*315mm
N.W.	6.1KG
Cavity capacity	180ml
Portafilter	58mm

PRODUCT FEATURE

- Vertical piston pressure
- Planetary gear for steady, effortless pressing
- Compact PID heating - powerful, dry-burn safe, keeps warm
- Side-mounted handle - clear space for direct pressing



Knob-adjustable PID Temperature Control

HAND PRESSED COFFEE MACHINE

CMFL003



PRODUCT FEATURE

- Vertical piston-type pressure application
- Planetary reduction gear, higher torque
- Full aluminum alloy housing

Model	CMFL003
Dimension	460*200*330mm
N.W.	7KG
Lever length	27cm



Drip tray



Pressure gauge



Brew group



COMMERCIAL COFFEE MACHINE

CMKM3000



Model	CMKM3000
Power	3000W
Volt/Frequency	200V / 50Hz
Dimension	420*580*380mm
N.W.	32KG
Packing size	665*650*755mm
G.W.	52KG
Boiler capacity	5L Steam + 1L Extraction

PRODUCT FEATURE

- Dual PID Temperature Control
- Adjustable Coffee Extraction Temperature (85–93°C)
- Adjustable Pre-infusion Time (0–60s) with Off Function
- Stepless Steam Power Control for Milk Frothing
- Adjustable Single-shot Coffee Flow & Precise Dosing
- Real-time Extraction Seconds Display
- Imported Italian Vane Rotary Pump with Circulating Water Inlet
- Dual Independent Pressure Gauges for Real-time Extraction & Steam Pressure Monitoring
- 4-Hole 360° Rotatable Stainless Steel Steam Nozzle

COMMERCIAL COFFEE MACHINE

CMKM3000A



PRODUCT FEATURE

- Dual PID Temperature Control
- Adjustable Coffee Extraction Temperature (85–93°C)
- Adjustable Pre-infusion Time (0–60s) with Off Function
- Stepless Steam Power Control for Milk Frothing
- Adjustable Single-shot Coffee Flow & Precise Dosing
- Real-time Extraction Seconds Display
- Imported Italian Vane Rotary Pump with Circulating Water Inlet
- Dual Independent Pressure Gauges for Real-time Extraction & Steam Pressure Monitoring
- 4-Hole 360° Rotatable Stainless Steel Steam Nozzle

Model	CMKM3000A
Power	3000W
Volt/Frequency	200V / 50Hz
Dimension	420*580*380mm
N.W.	32KG
Packing size	665*650*755mm
G.W.	52KG
Boiler capacity	5L Steam + 1L Extraction



COMMERCIAL PROFESSIONAL SMALL COFFEE ROASTER

IT-CBR-4



PRODUCT FEATURE

- Professional Compatibility: 150-300g optimal capacity, paired with patented dual-control simulated direct flame and dual sensors for precise temperature regulation; 9 preset roast profiles plus 100 custom storage slots, perfectly tailored to the flavor needs of diverse coffee beans.

Model	IT-CBR-4
Power	700W
Dimension	370*360*330mm
N.W.	7.5KG
Capacity	150-300g(Recommendedbaking amount: 200g)
Heating Method	Far infrared heating tube



Movable Bean
Collection & Cooling
Tray



Patented Innovative
Hopper Structure
Turbofan Technology

COMMERCIAL COFFEE BEAN ROASTER

CBR1000



Feeding Hopper



Sampling Spoon

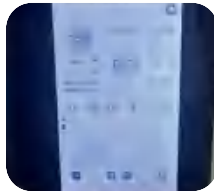

Control Cabinet

PRODUCT FEATURE



Model	CBR1000
Power	4550W
Volt/Frequency	220V 50Hz
Dimension	510*580*730mm
N.W.	40KG
Capacity	1000ml

COMMERCIAL COFFEE BEAN ROASTER

CBR300



Model	CBR300
Power	3400W
Volt/Frequency	220,50Hz
Dimension	273*400*420mm
N.W.	16KG
Bean hopper capacity	300g



Control System



Stainless Steel Cooling Tray

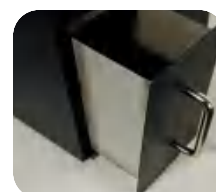

Chaff Drawer



COMMERCIAL COFFEE MACHINE

CMXY190



White
Black

PRODUCT FEATURE

- PID Dual Temperature Control; E61 Saturated Brewing Group; Dual-Boiler T3 Series
- Adjustable coffee extraction temperature (85–93°C)
- Adjustable pre-infusion time (0–60 seconds) with a shut-off function
- Adjustable extraction pressure & adjustable steam pressure
- Dual independent pressure gauges for real-time monitoring of extraction and steam pressure
- 4-hole stainless steel steam wand with 360° rotation

Model	CMXY190
Power	2000W
Volt/Frequency	220V / 50Hz
Dimension	340*450*410mm
N.W.	19KG
Pacing size	440*555*550mm
G.W.	25KG
Boiler capacity	2L



COMMERCIAL COFFEE MACHINE

CMXY192



PRODUCT FEATURE

- PID Dual Temperature Control; E61 Saturated Brewing Group; Dual-Boiler T3 Series
- Adjustable coffee extraction temperature (85–93°C)
- Adjustable pre-infusion time (0–60 seconds) with a shut-off function
- Adjustable extraction pressure & adjustable steam pressure
- Dual independent pressure gauges for real-time monitoring of extraction and steam pressure
- 4-hole stainless steel steam wand with 360° rotation

Model	CMXY192
Power	2800W
Volt/Frequency	220V / 50Hz
Dimension	340*450*410mm
N.W.	19KG
Pacing size	440*555*550mm
G.W.	25KG
Boiler capacity	2L Steam Boiler + 1L Brewing Boiler



COMMERCIAL COFFEE MACHINE



White Black

CMHF3000B



White Black

CMHF4800B

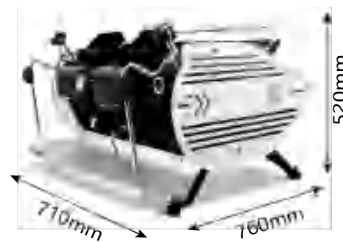

PRODUCT FEATURE



LED touch screen



Precision extraction



Dual-pressure display



Steam extraction



Standard flow rate



Milk-coffee dual system

Model	CMHF3000B	CMHF4800B
Power	3000W	4500W
Volt/Frequency	220V / 50Hz	220V / 50Hz
Dimension	440*760*520mm	710*760*520mm
N.W.	38KG	60KG
Pacing size	900*560*700mm	900*767*700mm
G.W.	50KG	73KG
Rated capacity	1L+4L	2L+6L

COMMERCIAL COFFEE MACHINE



White Black

CMJC3200B



White Black

CMJC4800B

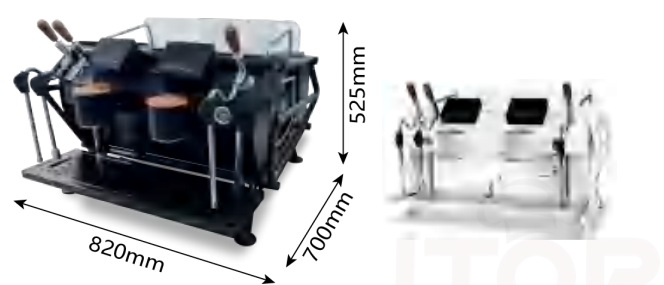
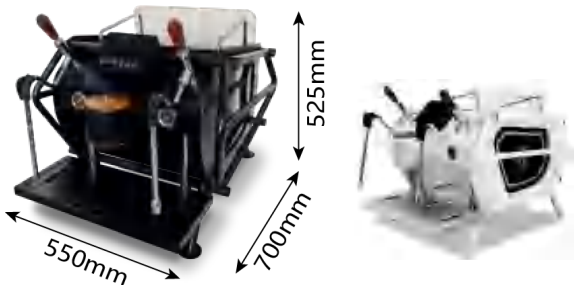

PRODUCT FEATURE



LED touch screen



Precision extraction



Dual-pressure display



Steam extraction



Standard flow rate



Milk-coffee dual system

Model	CMJC3200B	CMJC4800B
Power	3000W	4500W
Volt/Frequency	220V / 50Hz	220V / 50Hz
Dimension	555*700*525mm	820*700*525mm
N.W.	52KG	70KG
Packing size	850*655*700mm	940*810*700mm
G.W.	74KG	89KG
Rated capacity	1L+4L	2L+6L

COMMERCIAL COFFEE MACHINE



White Black

CMPX3200



White Black

CMSM4600B



PRODUCT FEATURE



LED touch screen



Precision extraction



Dual-pressure display



Steam extraction



Standard flow rate



Milk-coffee dual system

Model	CMPX3200	CMSM4600B
Power	3000W	4500W
Volt/Frequency	220V / 50Hz	220V / 50Hz
Dimension	345*540*425mm	680*540*425mm
N.W.	30KG	46KG
Pacing size	620*420*500mm	760*620*500mm
G.W.	41KG	62KG
Rated capacity	1L+4L	2L+6L

COMMERCIAL COFFEE MACHINE



CMYL3800B

CMYL5000B

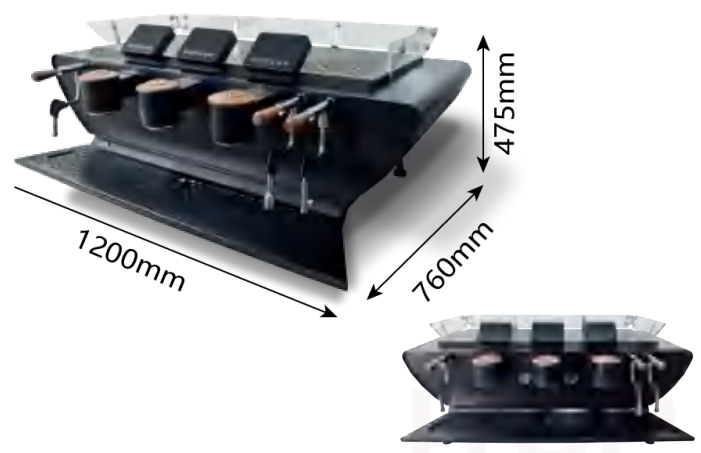
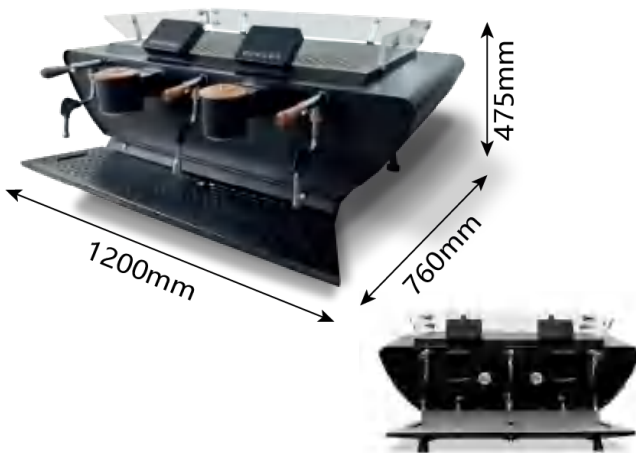

PRODUCT FEATURE



LED touch screen



Precision extraction



Dual-pressure display



Steam extraction



Standard flow rate



Milk-coffee dual system

Model	CMYL3800B	CMYL5000B
Power	4500W	5000W
Volt/Frequency	220V / 50Hz	220V / 50Hz
Dimension	1000*760*475mm	1200*760*475mm
N.W.	60KG	70KG
Pacing size	1115*920*715mm	1420*1020*720mm
G.W.	93KG	118KG
Rated capacity	2L+6L	3L+6L

COLD EXTRACTION COFFEE MACHINE

IT-CECM-1



PRODUCT FEATURE

Model	IT-CECM-1
Power	45W
Volt/Frequency	AC100-220V 50/60Hz
Dimension	230*260*380mm
Cavity capacity	2L
Timer	20/25/30min



Timing extraction
3 Levels-- 20/25/30min



Cups are separate
from the base,
easy to clean



2L large capacity



COMMERCIAL STEAM MILK FROTHER



SMF6LPro



SMF12LPro



SMFD12LPro



SMF12L



SMFD12L



- Plenty of steam for the perfect milk froth in your latte

Model	SMF6LPro	SMF12LPro	SMFD12LPro	SMF12L	SMFD12L
Dimension	190*360*475mm	250*365*605mm	250*365*605mm	260*280*638mm	260*280*638mm
N.W.	8KG	11KG	11KG	11KG	11KG
Packing size	450*242*535mm	460*315*675mm	460*315*675mm	450*340*715mm	450*340*715mm
G.W.	9KG	12KG	12KG	12KG	12KG
Water Output	20L/H				
Hot Water per Use	1500ml				
Steam Output	20-Min Continuous Steam				



COMMERCIAL COFFEE SHOP WATER PURIFIER FILTER



IT-WPE-2



IT-WPE-3



IT-WPE-4

PRODUCT FEATURE

- **Filter element:** PP melt-blown、 composite filter 、 antibacterial filter
- **High-precision filtration:** Multi-stage filtration
- **High-quality filter elements:** Imported filter media, pure taste
- **Leak-proof & safe:** Quick-connect sealed design, safe to use
- **Low cost:** Detachable filter cartridges
- **Green & energy-saving:** No electricity required, no wastewater discharge
- For catering businesses like tea houses and restaurants, it supplies clean drinking water for beverages and kitchen use. Installed in restaurants, eateries and bars, this series of water purifiers purifies water, enhances taste, improves the flavor of drinks and dishes, and ensures water safety.

Model	IT-WPE-2	IT-WPE-3	IT-WPE-4
Dimension	700*200*650mm	800*200*650mm	900*200*650mm
Applicable water temp.	2°C-38°C	2°C-38°C	2°C-38°C
Working pressure	0.1-0.4Mpa	0.1-0.4Mpa	0.1-0.4Mpa
Inlet & outlet	6-inch port	6-inch port	6-inch port
Outlet flow	3.7 GPM/min	5.5 GPM/min	7.5 GPM/min



SEMI-AUTOMATIC ESPRESSO MACHINE



White Black

CMJC3200



White Black

CMYL4500



LED touch screen



Precision extraction



Dual-pressure display



Steam extraction



Standard flow rate



Milk-coffee dual system



Food-grade stainless steel boiler



30-98°C Adjustable extraction temperature

PRODUCT FEATURE

- LED touch screen allows setting of extraction and steam temperatures, as well as pre-infusion time.
- Full copper heat-exchange brewing head maintains temperature using steam heat.
- Equipped with imported rotary pump and imported solenoid valve for longer machine lifespan.
- Independent boiler design shortens heating time and improves extraction efficiency.
- Effortlessly copes with a daily output of over 200 cups

Model	CMJC3200	CMYL4500
Power	3200W	3800W
Volt/Frequency	220V / 50Hz	220V / 50Hz
Dimension	555*700*525mm	1000*760*475mm
N.W.	52KG	60KG
Extraction boiler	1L/1200W	1L*2/800W*2
Steam boiler	3L/2200W	8L/2200W

ESPRESSO COFFEE MACHINE

CMHT5000

CMHT5200



Black
White

Black
White



Standard flow rate



LED touch screen



Dual-Pressure display



9bar Rotary pump



9bar Rotary pump



Milk & Coffee dual system

Model	CMHT5000	CMHT5200
Power	3000W	4500W
Volt/Frequency	220V/50Hz	220V/50Hz
Dimension	345*540*425mm	680*540*425mm
N.W.	33KG	49KG
Packing size	620*420*620mm	620*740*620mm
G.W.	38KG	59KG

COMMERCIAL COFFEE MACHINE



IT-CM-CR2



58mm extraction



9bar imported water pump



Import flowmeter



PID intelligent temperature control



LED LCD display



Pre-soaking system



Exchanger boiler



Four-hole steam nozzle head

Model	IT-CM-CR2
Volt/Frequency	220V 50Hz
Power	5200W
Dimension	740*700*525mm



Saddle-shaped forward-extending electroplated brewing head, with high-end wooden foot supports, pole rails, etc. Avant-garde design, stable texture.

CMDR4700



9Bar commercial rotary pump



PID intelligent temperature control



Four-hole steam nozzle head



LED LCD display



Pre-soaking system



2 units of 550ml extraction boilers





Model	CMDR4700
Volt/Frequency	220V 50Hz
Power	4700W
Dimension	828*715*590mm

COMMERCIAL COFFEE MACHINE



IT-CM-T1

-  Double split boiler
-  T3 Heating system
-  PID temperature control
-  American imported water pump
-  Precision ceramic seals
-  Precise flow control function
-  Saturated extraction head
-  All copper pipe connection

Model	IT-CM-T1
Voltage	220V/50Hz
Power	3500W
Material	Stainless steel+ wood
Pump type	Imported rotary pump 9 Bar
Machine size	438*560*450mm
N.W.	38kg



IT-CM-T2

-  Double split boiler
-  T3 Heating system
-  PID temperature control
-  American imported water pump
-  Pre-soaking time is freely set
-  Precise flow control function
-  Saturated extraction head
-  All copper pipe connection

Model	IT-CM-T2
Voltage	220V/50Hz
Power	6000W
Material	Stainless steel+ wood
Pump type	Imported rotary pump 9 Bar
Machine size	660*560*450mm
N.W.	56kg



SEMI-AUTOMATIC COFFEE MACHINE

MX-3



PRODUCT FEATURE

- 304 stainless steel with mirror finish & enamel paint.
- 360-degree rotating steam wand making perfect froth.
- Equipped with a microcomputer for one-touch start-up, automatic water heating, and built-in dry-burning protection.
- Humanized electronic buttons, with LED lights at the coffee outlet.
- Dual displays allow clear monitoring of water pressure and steam pressure during operation.
- Dual displays allow clear monitoring of water pressure and steam pressure during operation.

Model	MX-3
Power	4000W
Volt/Frequency	220V
Dimension	950*570*550mm
N.W.	77KG
Boiler capacity	16.5L



COMMERCIAL BUILT IN TEAPRESSO MACHINE

IT-CM-ML16

- PID temperature heating control technology, multi-function touch screen, high efficiency and energy saving, pre-infusion system
- Multiple boilers independently adjust the boiler temperature, the extraction temperature has the greatest flexibility, the temperature error is +0.5°C
- The top PID pressure control system allows you to operate more smoothly and clearly
- Humanized thumb touch button, LED light at the coffee outlet to see the extraction effect more clearly
- High-end LCD touch screen and surrounding LED lights show the pioneer of the times
- Multi-stage extraction can make coffee and tea at the same time

Model	IT-CM-ML16
Voltage	380V
Power	6KW
Dimension	920*420*858mm
Under counter size	920*420*400mm
Boiler capacity	13.5L



- White
- Black

IT-HPEM-2

- With milk frother, extraction and milk foaming at the same time
- Pressure sensor system reacts extraction pressure
- Independent double touch screen control interface, programmable, easy to adjust machine parameters, dynamic steam lighting
- Multiple boilers, each boiler independent temperature control/pressure control/brewing. P.I.D extraction temperature electronic control
- Imported professional rotary water pump and use rubber cushion anti-shock treatment
- Saturated brewing head to ensure consistency with boiler temperature

Model	IT-HPEM-2
Volt/Frequency	220V-380V / 50-60Hz
Power	5.3KW
N.W.	95KG
Under counter size	855*355*453mm
Hole size	860*370mm (length*width)
Coffee boiler	2Lx2pcs
Steam boiler	7.5L



COMMERCIAL PORTION-WEIGHT COFFEE GRINDER

IT-GE83W

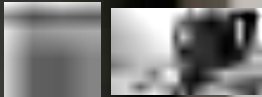

Model	IT-GE83W
Power	600-650W
Volt/Frequency	AC220-240V~,50/60Hz
Dimension	190*316*615mm
N.W.	14.7KG
Burr size	83mm flat
Bean hopper capacity	1100g

PRODUCT FEATURE

- **Ultra-Precision Grinding:** 83mm flat burrs + micron-level stepless grind adjustment, with real-time grind size display; dual weight/time modes, dual recipe storage, flexible powder compensation, and grinding error $\leq \pm 0.3g$
- **High-Efficiency Commercial Output:** 1100g large-capacity bean hopper, 600-650W powerful motor, ideal for high-volume coffee production in commercial settings





IT-GE83



ELECTRIC COFFEE GRINDER

- High-resolution full-color LCD touch screen with time, date and temperature display.
- Clean the safety protection switch with high priority, which is more in line with safe use requirements and prevents misoperation.
- Usage modes: filter handle mode, touch operation mode, manual mode, single dose mode, double dose mode.
- The electric charge in plasma is used to remove static electricity, preventing coffee powder splashing.
- **LED touch screen allows setting of extraction and steam temperatures, as well as pre-infusion time.**



Model	IT-GE83
Vol	AC220-240 V, 50/60 Hz (High-torque AC motor)
Power	580-600W
Dimension	192*316.5*605 mm
Burr Size	83MM Flate burr ,compatibility SSP burr
Grind speed	7-10GIS (250um)
Material	Body (Metal +ABS). Bean hopper (PC +ABS)
Bean hopper capacity	1000G



ELECTRIC COFFEE GRINDING



CG74A / CG74APro

Built-in weighing cell



Model	CG74A	CG74APro
Power	450W	450W
Volt/Frequency	220-240V/50Hz	220 / 50Hz
N.W.	15KG	15KG
Dimension	250*415*635mm	405*300*675mm
G.W.	17KG	17KG
Burr Size	72 mm (flat)	72 mm (flat)



CGZFA300

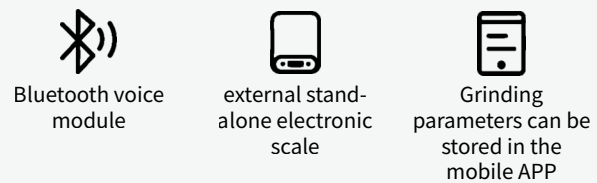

PRODUCT FEATURE

- Dual digital tube display with visual grinding gear/time
- Electrically adjustable grinding with 240 grind settings
- Patented powder shaking device, featuring automatic/manual powder cleaning (no residual powder)
- Plasma/anti-static device for direct powder discharge
- Cooling fan to ensure stability during continuous grinding

Model	CGZFA300
Power	700W
Dimension	230*183*352mm
N.W.	10KG
Bean hopper capacity	1300g
Burr Size	64 mm (flat)



<https://youtu.be/sGA4kFVym2Q>



Product Name	Commercial Coffee Grinder				
NO.	1	2	3	4	5
Model	IT-C98pro-DD	IT-C98pro-DL	IT-C98-DI	IT-C98PRO-DL-S	IT-CG-10G2.0
Voltage / Frequency	50-60Hz / 220V-240V				50-60Hz / 110V-240V
Rated power	1000w				600w
Machine Speed	2000RPM				1800RPM
Cutter Head Diameter	98MM				90MM
Cutter Material	SUS420 stainless steel / Titanium alloy				
Bean Bin Capacity	3.5pounds			2pounds	0.55pounds
Machine Net Weight	25.5KG	26KG	26KG	25KG	14.93KG
Machine Height	420 * 230* 800MM (Including bean hopper)	420 * 230* 890MM (Including bean hopper)		420 * 230* 420MM (Including bean hopper)	175 * 280* 535MM (Including bean hopper)
Color Selection	Black / White	Black / White	Black	Black / White / Green	Black / White
Coffee Powder	Grindable spaghetti and hand-brewed flour			1-16 levels of coarse and fine adjustment	Grindable SOE and Hand Punch
Burrs :					



COMMERCIAL COFFEE GRINDER



White Black

**DUAL-HEAD GRINDING SYSTEM
FOR HIGHER EFFICIENCY** !!



IT-C98PRO-DD2



Multi-grade adjustable thickness



Powder handle

Model	IT-C98pro-DD2
Volt/Frequency	220V
Power	1300W
N.W.	28KG
Burr size	98mm(flat)

IT-C98PRO-ST



Model	IT-C98pro-ST
Volt/Frequency	110V/240V,50/60Hz
Power	600W
Burr size	98mm(flat)



ELECTRIC COFFEE GRINDING



CGZFA500



Bluetooth voice module



Built-in weighing cell



OTA upgrade for mobile APP

PRODUCT FEATURE

- 4.3-inch TFT touch screen for real-time monitoring of grinding data
- Electrically adjustable grinding with 240 grind settings
- Patented powder shaking device, featuring automatic/manual powder cleaning (no residual powder)
- Plasma/anti-static device for direct powder discharge
- Parameter memory function with 50 preset grinding recipes
- Cooling fan for effortless continuous grinding

Model	CGZFA500
Power	500W
Dimension	210*130*280mm
N.W.	4.33KG
Bean hopper capacity	480g
Burr Size	90 mm (flat)



CGZFA700



Bluetooth voice module



Built-in weighing cell



OTA upgrade for mobile APP

PRODUCT FEATURE

- 5.0-inch TFT touch screen for one-click efficient operation
- Dual-motor precision grinding system with 240 grind settings
- Patented powder shaking device, with automatic/manual powder cleaning (no residual powder)
- Ion-based comprehensive anti-static device for direct powder discharge
- Cooling fan for effortless continuous grinding

Model	CGZFA700
Power	700W
Dimension	230*183*352mm
N.W.	10KG
Bean hopper capacity	1300g
Burr Size	64 mm (flat)





IT-TS58



COMMERCIAL COFFEE TAMPER

PRODUCT FEATURE



5-30kg pressure adjustment



Adjustable stand height

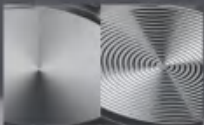

Flat Base & Threaded base for tampers



Automatic induction



Non-slip pad



Model	IT-TS58
Volt	12V
Power	30W
N.W.	4KG
Dimension	135*300*125mm
Coffee powder hammer	58MM
Pressure adjustment	5-30KG



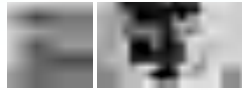

ELECTRIC COFFEE TAMPER



Model: IT-58

Power: 100w

Voltage: 110-240V 50/60Hz

Product Size: 14x21x27.3cm

Packing Size: 21.5x26x39cm

Tamper Diameter: 58mm/Customizable

N.W./G.W. : 4.5kg/5.5kg

Material: Plastic+304 Stainless Steel
+Aluminum Silver Coating

Color:



Horizontal Line



Non slip pad

How to use



<https://youtu.be/obFmfx2UJ4c>

Automatic Coffee Tamper



Product Name: Spinning Powder Press	
Model: IT-X580	Power: 100W
Rated Frequency: 50-60 HZ	Tamp Times: 1 time
Voltage: 110V/60Hz,220-240V/50-60Hz	
Tamper Material: Stainless Steel	Spinning Speed: 100RPM
Control Pannel Material: Plastics	Pressure Range: Spinning
Pressure: 10 to 30kg adjustable	Tamper Diameter: 58MM
Housing Material: 304 Stainless Steel	
Product Color: Black/White/Gray	Net Weight: 6.64kg
Product Size: 110*165*330MM	Packing Size: 247*145*383MM
Package List: Machine X1.Powersupply X1	

Product Details



Threaded flour hammered nozzles



Performance Control Panel



Handle powder bowl holder



Knob bracket adjustment



Metal sensors



Non-slip design on the bottom



IT-DM58 Coffee Tamper



Control Panel

Coffee Hammered

The IT-DM58 mill can be matched with this grinding machine, as the stage component of this grinding machine, the two machines can form a grinding machine, both machines can be purchased separately.

Rated Voltage (v): 24v
Rated Frequency (Hz): 50-60Hz
Rated Power: 100W
Powder Hammer Diameter: 58MM
Pressure Adjustment Range :10-30KG
Pressing Method: Direct Pressing
Machine Color: Black/White
Power Cord: According to customer requirements
Net Weight :8.1KG
Outer Box Size :345*297*272MM



ELECTRIC COFFEE TAMPER



COFFEE PULLING MACHINE REPORT





AUTOMATIC TAMPING COFFEE GRINDER

CGTP2000



Model	CGTP2000
Power	600/670/750/820W
Voltage	220V
Dimension	210*365*490mm
N.W.	14KG
Speed	1400/1600/1800/200RPM
Bean hopper capacity	1000g
Burr size	74mm (titanium coated flat burrs)

PRODUCT FEATURE

- Brushless DC motor
- 10-level electric control coarseness
- 4-speed settings
- 4 grinding modes: Standard, Direct, Preselection, Automatic
- 4.3" smart touch screen
- Metal induction sensor
- Multilingual, Regular maintenance reminder



ELECTRIC COFFEE GRINDING



White Black



IT-90B



• 90mm Flat Knife

TECHNICAL DETAILS

Model	IT-90B
Volt/Frequency	220-240V, 50-60Hz
Power	900W
N.W.	20KG
Dimension	300*210*560mm
G.W.	30KG
Burr Size	90 mm (flat)
Powder Hammer Bottom Shape	Flat Bottom



White Black



MY-G



• 98mm Flat Knife

- Fast speed, from grinding, quantitative to pressing powder, the whole process is only 7s
- Closed state work, do not waste coffee powder
- The overall density of the powder is uniform

TECHNICAL DETAILS

Model	MY-G
Volt/Frequency	220V-240V, 50-60Hz
Power	1000W
N.W.	29.5KG
Dimension	426*166*627mm
G.W.	32KG
Packing size	715*300*780mm
Burr Material	98 mm (flat)
Burr Material	SUS420 stainless steel
Operating speed	2000r/min





IT-CPCR-2

COFFEE HANDLE CLEANER

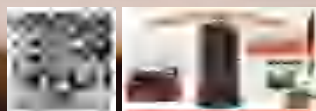

PRODUCT FEATURE



Quick Cleaning



Easy Disassembly



One-Button Start

FULL BODY DETACHABLE STRUCTURE



Model	IT-CPCR-2
Vol	12V DC
N.W.	4KG
Dimension	230*350mm
Burr size	48 mm
Rated speed	352 RPM +12%



Easy to use
Quick cleaning



Power on

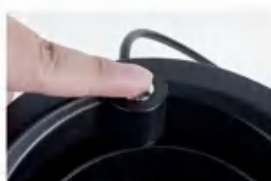

Press the switch button



Press the handle down to scrape off the



DRAWER-TYPE ELECTRIC PORTAFILTER CLEANER

KFQJ58CT

PRODUCT FEATURE

- It can be directly placed at the bottom of the bean grinder
- Most bean grinders are suitable



- Easy to disassemble and clean



Model	KFQJ58CT
Power	150W
Voltage	110V-220V
Dimension	475*280*180mm
N.W.	8.5KG
Motor speed	300RPM



ELECTRIC COFFEE PORTAFILTER CLEANER

IT-58CPCR

PRODUCT FEATURE

- **Full Body detachable structure**
Clean without residue
- **Large capacity slag tank**
Can make coffee about 20 times in a row



Model	IT-58CPCR
Power	30W
Input Voltage	110V-240V/50Hz-60Hz
Output Voltage	DC12V 20W
Dimension	255*135*215mm
N.W.	1.5KG
Packing size	303*195*330mm
G.W.	2.2KG
Drum capacity	2L
Available coffee Portafilter	51mm~58mm
Motor speed	350RPM





DRIED FRUIT MACHINE



PRODUCT SHAPE



Cleaning Powder



Cleaning Powder



Cleaning Powder

PRODUCT FEATURE

- Main ingredients: Na_2CO_4 , Na_2CO_3
- Using active chlorine formulation. Non-skin damage, biodegradable, safe and reliable.
- Remove stains efficiently, easy to rinse with no residue.
- Mainly used for **coffee stains**



Cleaning Powder

SUITABLE FOR USE ON

- All types of coffee equipment, frothers and coffee ware etc.



CLEANING METHODS



1. Use cleaning to brush off the coffee residue on the water network



2. Pour the powder bowl into the clean powder



3. Lock the handle and boil the head

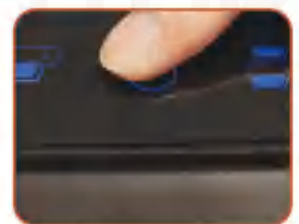

4. Stop it after pressing ten seconds, static for ten seconds, and repeat the above action 4 times



5. After unloading the handle, pour the residual medicine powder and lock the handle again and repeat the brewing action



6. Remove the handle and press the pumping key to rinse the handle

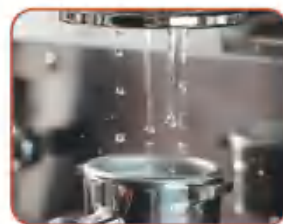

7. After the handle is rinsed, pour the water and wipe it clean

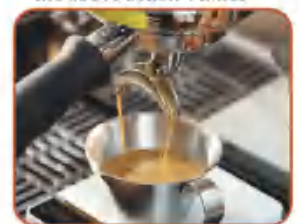

8. After the cleaning is completed, the first cup of coffee is dumped to ensure that there is no residue of clean powder





STARBUCKS SERIES

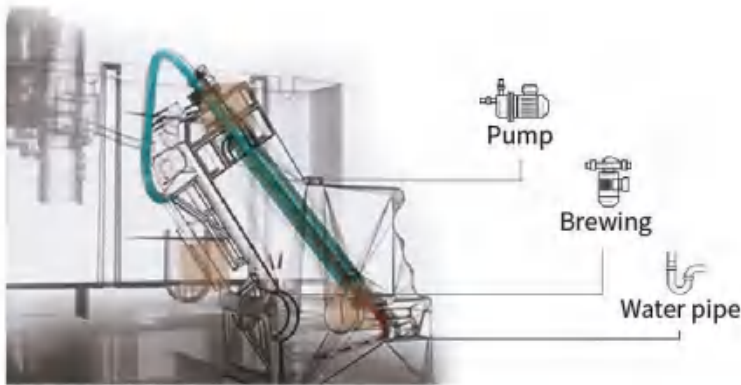

Cleaning Powder



Cleaning Powder

SUITABLE FOR USE ON

- All types of coffee equipment brew heads, pipefittings cleaning, utensils and frothers

CLEANING METHODS



1. Water tank adds water (remove the filter first)



2. Select cleaning program



3. Clear the dripping disk and put it back to the machine

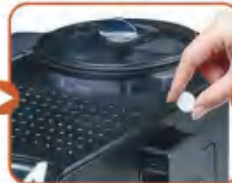

4. Open the coffee powder box and put in a cleaning tablet



5. Restart after cleaning



6. Clear the dripping disk again and put it back to the machine

NACTIVE DESCALING POWDER

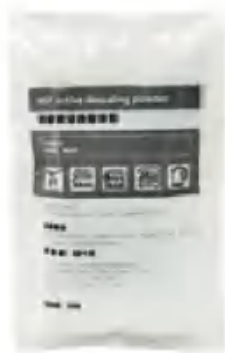

PRODUCT FEATURE

- Main ingredients: **Phosphate-free formula**
- Effective stain removal, biodegradable, safe to use.
- Remove the accumulated mineral dirt.
- Mainly used for **coffee stains**

SUITABLE FOR USE ON

- It is suitable for the cleaning of coffee machine pipelines, cleaning of boiler water tanks, water heaters, faucets, and stainless steel bar counters, etc.



FULLY AUTOMATIC COFFEE MACHINE

IT-ATC-KS1

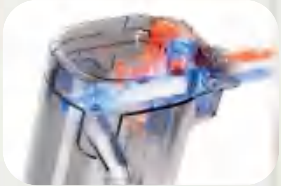

- **Dual Cooling Technology**
Instant hot & cold milk foam – no tank switching required
Efficient low-temperature extraction in just 1 minute



- **6.86-inch Large Screen Display for Flexible Control**



Model	IT-ATC-KS1
Power	1400W
Voltage	220V
Dimension	215*456*371mm
N.W.	9.95KG
Bean hopper capacity	250g
Pump	20Bar
Water tank capacity	1.3L
Milk tank capacity	450ml
Grinding levels	9



250g enlarged bean hopper



1300ml water tank



Cleaning tablet inlet



Adjustable liquid outlet



AUTOMATIC COFFEE MACHINE

ATCM1600



- **Large Capacity, Long Endurance**
750g extra-large coffee bean hopper, paired with a 6l water tank, enabling uninterrupted continuous output

Model	ATCM1600
Power	1500W
Volt/Frequency	220-240 V / 50-60 Hz
Dimension	526*391*572mm
N.W.	18.4KG
Packing size	630*500*730mm
G.W.	22.8KG
Water tank	6L
Bean hopper capacity	750g
Coffee drip tray	2L
Coffee grounds container capacity	50 blocks

PRODUCT FEATURE



- **Consistent output**
The newly upgraded grinding, brewing, and water circuit systems balance high-standard extraction with overall machine stability

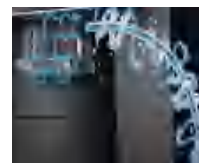

- **Intelligent Cleaning**
Milk foam self-cleaning system, easy to maintain



AUTOMATIC COFFEE MACHINE

IT-ATC-30S1/2



64mm flat cutterhead



Dual heating system

- Intelligent lack of beans reminder
- Water tank lack of water reminder
- Disassembled water tray



7-inch touch screen



Intelligent cleaning



Pre-soaking



Model	IT-ATC-30S1	IT-ATC-30S2
Volt/Frequency	220/240V , 50/60Hz	220/240V , 50/60Hz
Power	1550W	1550W
N.W.	15KG	15KG
Dimension	300*490*540mm	300*490*540mm
Bean box capacity	1200g	1200g
Water tank capacity	2 Linner water-tank; Barrel water or tap water	
Burr size	64mm	64mm

IT-ATC-30B1/2



64mm flat cutterhead



Dual heating system

- Intelligent lack of beans reminder
- Water tank lack of water reminder
- Disassembled water tray



7-inch touch screen



Intelligent cleaning



Pre-soaking



Model	IT-ATC-30B1	IT-ATC-30B2
Volt/Frequency	220/240V , 50/60Hz	220/240V , 50/60Hz
Power	1550W	1550W
N.W.	15KG	15KG
Dimension	300*490*540mm	300*490*540mm
Bean box capacity	1200g	1200g
Water tank capacity	8 Linner water-tank; Barrel water or tap water	
Burr size	64mm	64mm



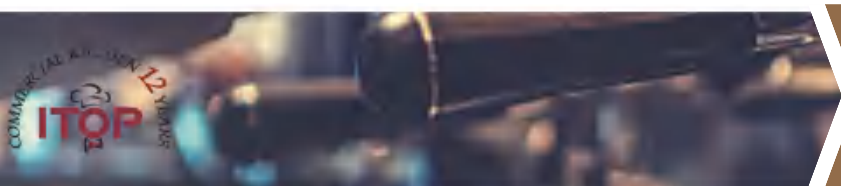

OFFICE COFFEE CORNER SERIES

COMMERCIAL COFFEE MACHINE

IT-FCG500



White Black

- Dual purpose coffee bean/powder
- 7 -inch display
- Self-cleaning on the inside of the machine
- Coffee bean grinding coarse and fine adjustment
- Automatic water, large waste box

Model	IT-FCG500
Volt	220VAC
Power	1900W
N.W. / G.W.	30KG / 32KG
Dimension	728*240*335mm
Bean warehouse capacity	500-1450G
Water tank capacity	3.5L

IT-CIM-12



Personalized menu design, simple operation, easy to use

- Eyes catching colourful touch screen, easy to operate.
- Personalise the ratio of coffee, sugar and milk on the UI.



40s quick production, one click to fresh coffee

- 20s for instant beverages, 40s for coffee beverages.
- Fully automatic produce, instant heating.



IOT (Internet Of Things) management

- Support remote monitoring and maintenance of machines.
- The cloud platform greatly improves efficiency and reduces costs.

Model	IT-CIM-12
Power	2000W
N.W.	57KG
Dimension	700*420*450mm

IT-CIM-M6



- A high-performance professional gear pump delivers stable pressure for the best-tasting coffee



Ergonomic design for great coffee

- Independent hot water nozzle.
- Adjustable height for dispensing to meet different cup sizes.



Intelligent IOT (Internet Of Things) management

- Remote monitoring and maintenance of machines.
- The cloud platform improves efficiency and reduces costs.

Model	IT-CIM-M6
Power	2000W
N.W.	57KG
Dimension	700*420*450mm



VERTICAL FROZEN BOX



IT-ZB60



Large Capacity



Removable Shelves Height Adjustable Can put ice cream and intensehard liquor

- Fresh milk preservation, the perfect partner for fully automatic coffee machines.

TECHNICAL DETAILS

Model	IT-ZB60
Volt/Frequency	115V/60Hz, 220~240V/50Hz
Dimension	445*545*645mm
Packing size	500*630*717mm
Effective volume	65L
Refrigerant	R600a
Control means	Mechanical Control
Loading quantity	249pcs/40GP

MATCH COFFEE REFRIGERATOR



IT-ZB5/IT-ZB5G



- Can match with coffee machine

TECHNICAL DETAILS

Model	IT-ZB5/IT-ZB5G
Volt/Frequency	220-240V/50Hz, 115V/60Hz
Dimension	180*465*460mm
Packing size	275*550*545mm
Effective volume	5L
Refrigerant	R600a
Control means	Mechanical Control
Loading quantity	688pcs/40GP



MILK COOLER



IT-9LS



- Glass door, blue internal

■ TECHNICAL DETAILS

Model	IT-9LS
Voltage/ Power	220V/ 50Hz/ 50W
Temperature	2-4 °C
Refrigerant	R600a
Capacity	9L
Cooling method	Compressor/ Air cooling
Product size	220*450*374mm

IT-J9LS



- Metal door, blue internal

■ TECHNICAL DETAILS

Model	IT-J9LS
Voltage/ Power	220V/ 50Hz/ 50W
Temperature	2-4 °C
Refrigerant	R600a
Capacity	9L
Cooling method	Compressor/ Air cooling
Product size	220*450*374mm



MILK COOLER



IT-9L



- Glass door, blue internal



- LED control panel

■ TECHNICAL DETAILS

Model	IT-9L
Voltage/ Power	220V/ 50Hz/ 50W
Temperature	2-4 °C
Refrigerant	R600a
Capacity	9L
Cooling method	Compressor/ Air cooling
Product size	220*450*454mm



IT-J9L



- Metal door, blue internal

■ TECHNICAL DETAILS

Model	IT-J9L
Voltage/ Power	220V/ 50Hz/ 50W
Temperature	2-4 °C
Refrigerant	R600a
Capacity	9L
Cooling method	Compressor/ Air cooling
Product size	220*450*454mm





AUTOMATIC COFFEE MACHINE

One-Click Brewing for Multiple
Coffee Flavors



- T SERIES
- R SERIES

One touch screen
Fully automatic grinding

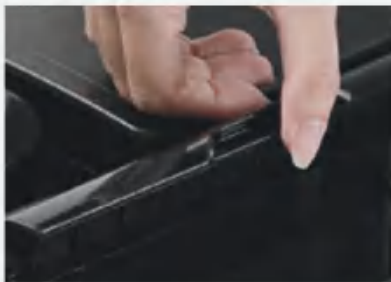

· Tank handle groove



· Pull the groove out of the
waste water



· Brewing unit latch



· Grinding beans can
be adjusted



· Increased platform with
adsorption function



· The back accelerates heat
dissipation





WIFI CONTROL

SMART ACONTROL PANEL



TWO BEAN TANK

Optional coffee to bean ratio,

CORE TECH REVELATION

The vertical dropping of grounds Best minimize the remaining of coffee powder

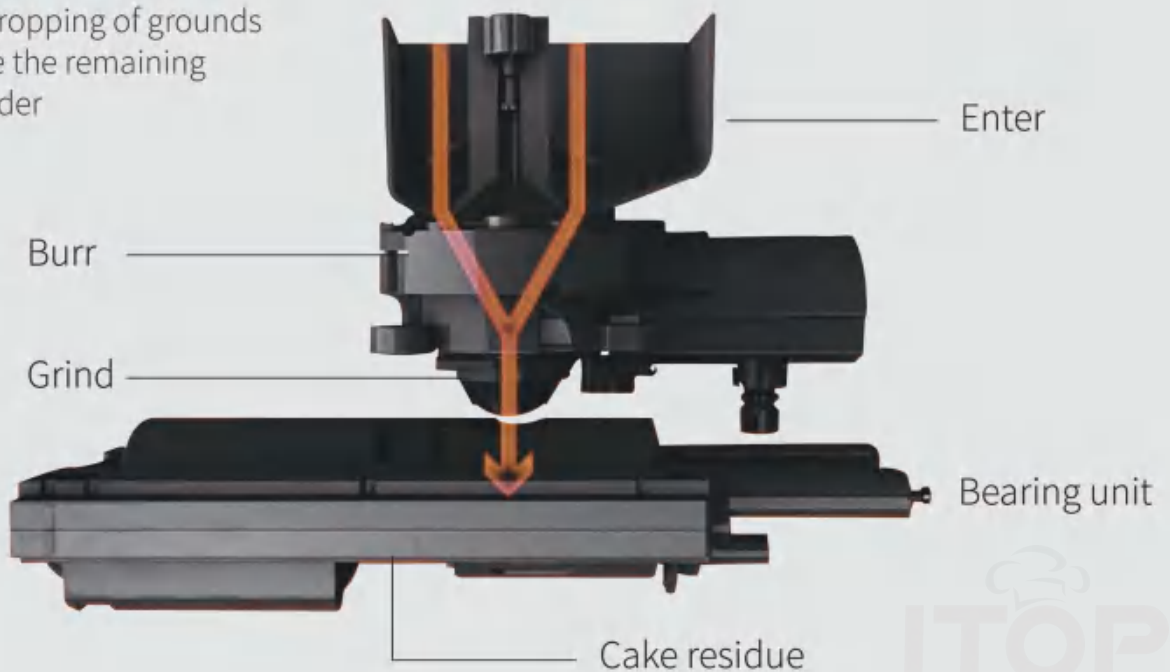

REFRIGERATION SYSTEM

With the patented constant-temperature cooler milk timer system

With a built-in sensor checking the milk status whenever



Innovative horizontal brewing unit

Waste water drawer & residue drawer



Individual heater



IT-T6



Model: IT-T6
 Volt/Frequency: 100-120/220-240V 50/60Hz
 Power: 1480W
 Weight: 11.3KG
 Dimension: 245*320*425mm
 Water tank capacity: 1.5L
 Pump: 19bar
 Bean container capacity: 150*2g
 Grounds container capacity: 10-15Pcs
 Bolier: 2Pcs

IT-T6-B/F

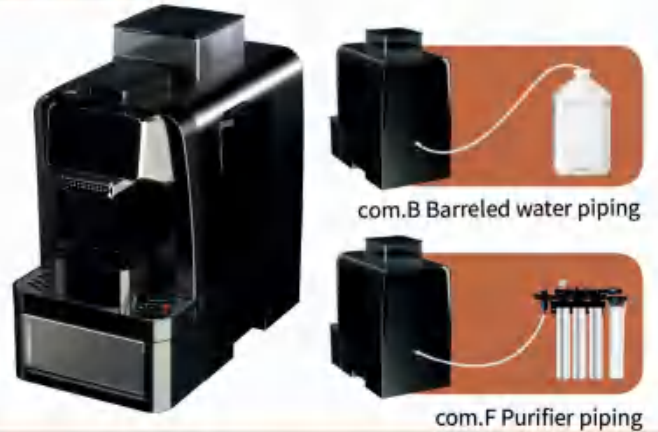

Model: IT-T6-B/F
 Volt/Frequency: 100-120/220-240V 50/60Hz
 Power: 1480w
 Weight: 28KG
 Dimension: 245*460*425mm
 Water tank capacity: 1.5L automatic water feeding
 Pump: 19bar
 Bean container capacity: 570g
 Grounds container capacity: 50Pcs
 Bolier: 2Pcs

IT-T3



Model: IT-T3
 Volt/Frequency: 100-120/220-240V 50/60Hz
 Power: 1480W
 Weight: 10.2KG
 Dimension: 245*320*425mm
 Water tank capacity: 1.5L
 Pump: 19bar
 Bean container capacity: 150*2g
 Grounds container capacity: 10-15Pcs
 Bolier: 2Pcs

IT-T3-B/F



Model: IT-T3-B/F
 Volt/Frequency: 100-120/220-240V 50/60Hz
 Power: 1480W
 Weight: 27KG
 Dimension: 245*460*425mm
 Water tank capacity: 1.5L automatic water feeding
 Pump: 19bar
 Bean container capacity: 570g
 Grounds container capacity: 50Pcs
 Bolier: 2Pcs

Automatic coffee machine

Certification : 3C/CE/GS/CB/KC/SAA/ROHS

Household



Model: IT-ACM7S

Specification

Size : 350*350*390mm
 N.W./G.W. : 8/11kg
 Coffee spout height adjustment range : 7.5-13cm
 13cm Coffee cup volume adjustment range : 30-200ml
 Coffee temperature : > 85°C
 Bean box capacity : 250g
 Water tank capacity : 1.8L
 Waste box capacity : 10 cups
 Electromagnetic pump parameters : ULKA 19Bar

Function Introduction

1. Independent coffee making system
2. Professional electromagnetic pump from Italy UL KA 19BAR
3. The amount of coffee beans and the thickness of each cup of coffee can be adjusted
4. Language alarm function: it will automatically alarm when you make a mistake in operation
5. Detachable brewer Drip tray for easy cleaning and cleaning

Model: ①IT-CM-OFT19 ②IT-X8 ③IT-CM-OFT50

Specification	①	②	③
Bean Bin Capacity :	250G	250G	250G
Pump Pressure :	19BAR	19BAR	19BAR
Voltage :	220VAC	220VAC	220VAC
Power :	1200W	1200W	1200W
Water Tank Capacity :	2L	2L	1.8L
Brewer Capacity :	8-12G	8-12G	8-12G
Product Size :	450*240*345MM	450*240*345MM	445*240*335MM
N.W. /G.W.:	11/13.2KG	12/13.8KG	12.5/14.5KG

Function Introduction

- | | | |
|--|---|---|
| ① 3.5 inch screen
Dual purpose coffee bean/powder
Separate brewer
Can make 5 kinds of drinks
Self-cleaning inside the machine on
Double cups of coffee can be made at a time
Italian ULKA water pump | ② 5 inch screen
Dual purpose coffee bean/powder
Separate brewer
Can make 19 kinds of drinks
Self-cleaning inside the machine on
Double cups of coffee at a time
Italian ULKA water pump | ③ Large 7-inch screen
Separate brewer
Dual purpose coffee bean / powder
Can make 19 kinds of drinks
Self-cleaning inside the machine on
Double cups of coffee can be made at one time
Italian ULKA water pump |
|--|---|---|

Light commercial



Commercial



Model: IT-FCG500

Specification

Bean Bin Capacity : 500-1450G
 Pump Pressure : 19BAR
 Coffee Flow Rate : 30-250ML
 Coffee temperature : 75°C-95°C
 Voltage : 220V
 Power : 1200W
 Water Tank Capacity : 1.8L
 Brewer Capacity : 8-12G
 Product Size : 450*240*330MM
 N.W./G.W.: 10.5/29KG

Function Introduction

- | | |
|---|--|
| One-touch fancy coffee | Self-cleaning on the inside of the machine |
| Milk foam function | Coffee bean amount adjustment |
| Dual purpose coffee bean/powder | Dual purpose coffee bean/powder |
| Coffee bean grinding coarse and fine adjustment | Coffee flow adjustment |
| 19bar high -pressure extraction | |





OFFICE COFFEE CORNER SERIES

Coffee Printer



Product Name	Coffee Pulling Machine Report				
Model	IT-MCP	IT-PCP	IT-CFCP	IT-YCP-C	LAP-300
Machine size	33*19*44cm	27*34*41cm / 42*35*55cm		25.8*30.6*46.3cm	30.7*21.6*35.3cm
Package size	54*42*28cm				
Weight	9kg	12KG		12kg	5kg
Voltage	110V/220-240V			AC100V-240V	
Print accuracy	200dpi	600dpi	600dpi	600dpi	600dpi
Body color	Silver white / Glossy black			Same as picture	
Ink optional color	Brown		Colorful	Brown	
Print speed (sec)	20~40S	5~15S	20~50S	10~12S	
Body material	Metal			ABS plastic	
Cup height range	5~24CM/4~10CM	5~18CM/4~10CM		6.5~17CM/10CM	2.5~15CM/10CM
Print cup diameter					
Features	Small size, small footprint, cup height can support 24cm	High precision, fast and good imaging	Print color	Fast printing speed	Small size, suitable for home use.

Natural caramel ink is safe and reliable

Natural caramel ink, non-artificial coloring, passed a number of food-grade safety fully certified, food grade cartridge, no sponge design. The nozzle is integrated with the ink cartridge, which can be replaced immediately after use to avoid the breeding of bacteria.



Ink optional color	Brown	Colorful	Brown
Single cartridge printing times	800 ~ 1000 Times	600~800 Times	
Ink cartridge shelf life	Unopened 1 year, unpacking recommended 1 month to use up		

How to print? Scan code or print through browser



Select a 'Gallery' image or WeChat scan code to upload personalized pictures



Click the print button to print immediately



It only takes 10 seconds to create a sense of happiness

What can be printed on?



Coffee milk foam



Biscuit



Milk cap tea



German stout



Small cake



Yogurt



Ice cream



Chocolate



SEMI-AUTOMATIC ESPRESSO MACHINE



IT-CBC1



IT-CBC2



Effect Improvement



Firm Fuselage



Convenient For Cleaning

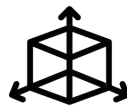

Elegant Appearance



Easy to use



Durable

PRODUCT FEATURE

- Rotating Coffee Bean Cooler
- Strong heat dissipation, doubling the cooling capacity
- Coffee beans roasting heat dissipation plate
- Convenient for cleaning
- Firm fuselage
- Elegant appearance
- **Suitable Scenarios:**
Milk Tea Shops, Coffee Shops, Households, Western Restaurants.

Product details



5mm mesh screen



Mesh screen with handle



High-powered fan

Model	IT-CBC1	IT-CBC2
Power	20W/38W	50W
Volt/Frequency	110V/60HZ,220-240V/50HZ	110V/60HZ,220-240V/50HZ
Dimension	260*260*200mm	250*200*250mm
N.W.	1.6KG/1.7KG	2.9KG



HAND PRESSED COFFEE MACHINE

CMFL001



Model	CMFL001
PID Power	180W
Dimension	205*470*315mm
N.W.	6.1KG
Cavity capacity	180ml
Portafilter	58mm
Blade material	Stainless steel

PRODUCT FEATURE

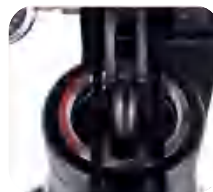

Vertical piston pressure



Planetary gear for steady, effortless pressing



Compact PID heating - powerful, dry-burn safe, keeps warm



HAND PRESS COFFEE MACHINE

HCM-M2

PRODUCT FEATURE

- Original patent
- Telescopic rod
- Pull water box



Model	HCM-M2
Dimension	280*130*420mm
N.W.	6.5KG
Extraction pressure	1-16bar
Water tank capacity	445ml (stainless steel) 345ml (quartz glass)



• Quartz glass



• Stainless steel



SMART CONTROL MODULE

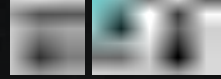

PRODUCT FEATURE

- **Smart App Control with One-Tap Bluetooth Connection**
Seamlessly connect to the roaster via Bluetooth through the Hibeans app. Intuitive device dashboard provides quick access to preheating, fan speed control, drum rotation speed, and cooling functions.
- **Automatic Roasting with Intelligent Profile Recall**
The system automatically loads your last used roasting profile (e.g., 300g batch size). Fully automated roasting by strictly following preset curves ensures consistent quality.
- **Professional Roasting Workflow: Preheat → Charge → Development → Cooling**
Step-by-step automated process ensures stable temperature control and reproducible results. Visual timeline keeps users informed of progress at each roasting stage.





IT-CBR-1

ELECTRIC COFFEE ROASTER

- Simulate direct fire baking
- With smoke filter
- With coffee chaff collector

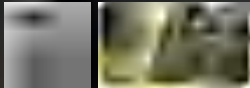

Model	IT-CBR-1
Voltage	220-240V/50-60HZ, 110V/60HZ
Power	1000W
Heat Transfer Mode	Drum Rotating
Material	S/S
Baking capacity	350-400g
N.W.	9.6kg
Machine Size	492*264*402MM

You can also become a baking master



Simulate direct fire baking



With smoke filter

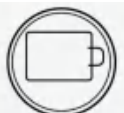

With coffee chaff collector





ELECTRONIC COFFEE ROASTER

IT-CBR-2



-  Enhanced hardware configuration
-  Patented direct fire baking simulation
-  Dual system control
-  Featured firepower curve
-  Quick bean temperature cooling
-  Dual temperature channel monitoring

• Rapid cooling & smoke purification system

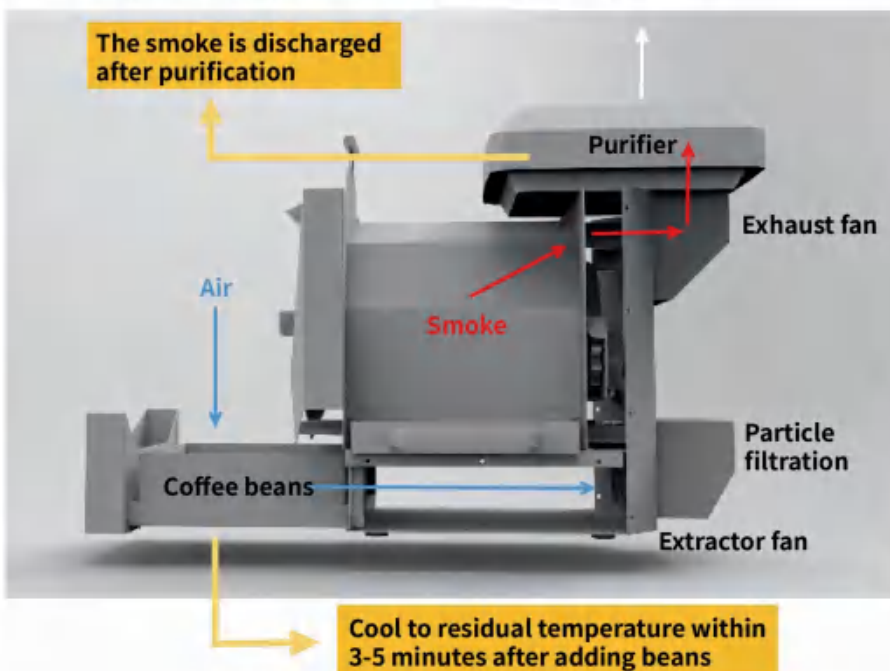

• Direct fire simulation baking system

Patented drum-mounted heating structure

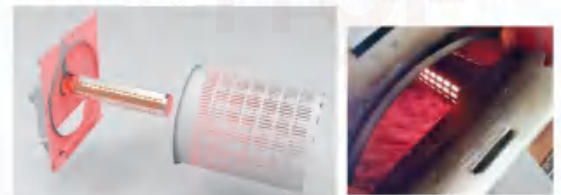

Coffee beans are closer to the heat source
Roasted to produce a direct fire-like aroma

SCR firepower regulation module



The firepower adjustment response is directly stable, solving the pain point that it is difficult to control the firepower of general electrothermal baking machines.



• Hardware configuration enhancement and transformation



Upgraded high torque brushless motor

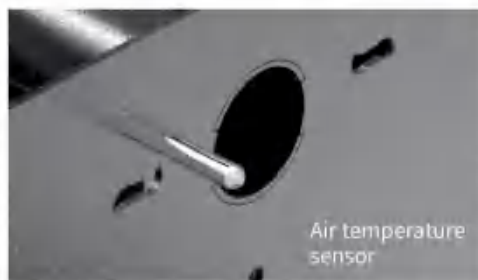

Upgraded dual temperature channel detection



Bean temperature probe



Upgrade circuit cooling device

• Designed according to the professional coffee roasting process, it can carry out uninterrupted flowing roasting operations.

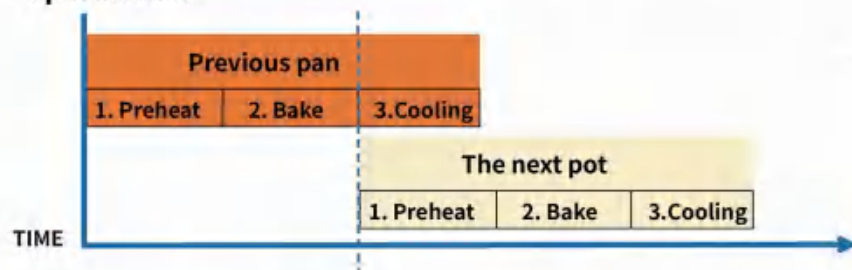

• 7-inch LCD touch screen



Matte metal frame

• Ability to save, reference, input, and import baking curves

<https://youtu.be/obFmfx2UJ4c>



Direct Fire Imitating (Patent)



Regional flavor curve



Smokeless



3 Stage Roast Modes



High Efficiency



Fresh Taste

Electric coffee roaster

Home / Commercial

Baking mode: Barrel type

Heating mode: Far infrared carbon heating tube

Power: 1000W

Voltage: ~220-240V 50-60 Hz 110-120V 50-60 Hz

Size: L 492 X W 264 x H 402 mm

Maximum baking volume: 500 g

Optimum baking amount: 350 g

Material: Food grade 304 stainless steel (body), Polycarbonate PC (controller)

Accessories: stirring rod*1, brush*1, spoon*1

Control mode: DIY craftsman mode / special automatic mode

Safety certification: CE, SAA, ETL, 3C

DIY worker mode professional control experience

Control design integrates professional baking operations

Through the adjustment of firepower and exhaust air, it can meet the temperature rise requirements of different development stages of baking. Combined with real-time monitoring of ROR to ensure that coffee beans develop according to the expected plan.



Simulated direct fire baking system

Built-in heating pipe in the drum (patented)

Coffee beans are closer to the heat source and absorb heat more effectively. Flavor and taste experience are closer to direct fire baking.

SCR Power Conditioning Module

Stable thermal output and quick adjustment response. Fire power control, as easy as direct fire baking.



Rapid cooling & smoke purification system

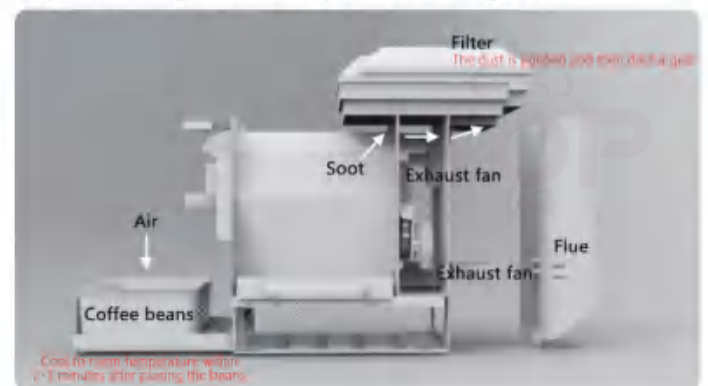

Rapid cooling & smoke purification system

Design based on SCA coffee roasting standards

Set parameters in accordance with the development stages defined by professional baking in the "torographic period, relay period, and development period". Professional adjustment and optimization by certified coffee roasters.



Coffee Bean Roaster



① IT-CBR-1



② IT-N-CR1000

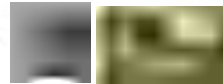

③ IT-ASCR300



Model	IT-CBR-1	IT-N-CR1000	IT-ASCR300
Baking Mode	Drum-type	Drum-type	Drum-type
Heating Mode	Far infrared carbon heating tube	Insert type symmetrical heating Built-in thermostat for wok	Hot Air
Power	1000W	1600W	1600W
Voltage	110V/220V	220V/50Hz	110V-240V/ 50Hz-60Hz
Specification	20*42.5*40cm	25.5*43.1*30 cm	46*20*22 cm
Maximum Baking Capacity	500g	1000G	300g
Temperature range		100°C-250°C	7 Gears
Control Mode	DIY Craftsmen Mode / Special Automatic Mode	Digital display	Button panel
Material	Food-grade 304 stainless steel (body) Polycarbonate PC (controller)		Stainless steel diamond roller bean bin
Product Description	Simulated direct fire baking system, stable heat output, rapid adjustment response Rapid cooling & dust purification system Featured automatic mode Professional baking curve	Accurately control firepower every 1°C Built-in heat sources on both sides three-dimensional heating, more even. The funnel-type design of the bean entry port allows for quick entry of beans without any lag. Top touch operation digital display.	Hot air roaster, automatic baking for home office use; The operation is simple, there are multiple grades to choose, mild baking to deep baking 7 grades can be adjusted; Comes with cooling function.





IT-CBR-3



COFFEE ROASTER

PRODUCT FEATURE

- Pure electric design
- Turbofan drum structure
- Simulated direct fire baking
- Intelligent dual baking mode
- Cooling-Smoke Filtering-Dust Collection



Model	IT-CBR-3
Voltage	110-220V/50-60HZ
Power	700W
Roller	Turbofan Architecture
Heating	Built-in far infrared carbon tube
Baking capacity	200g
Curve setting	Intelligent program
Material	S/S

Three-blade stirrer mixing method enables higher efficiency of the bean roaster and more stable output



ELECTRIC BEAN GRINDER

CGB150-5

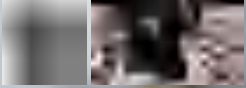

Model	CBG150-5
Power	72W (load power 150W)
Motor	24V 140 -rpm High -Power Torque Silent Motor
Adapter	24V 3A (load power 150W)
Dimension	118*103*260mm
N.W.	1.8KG
Packing size	357*216*123mm
G.W.	2.3KG
Hopper capacity	18g
Burr	SS420/Dia.48mm conical type



High-torque gear motor



Seven-star precision steel grinding core

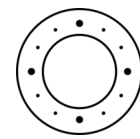

Point-type adjustment



Selected materials



COMMERCIAL COFFEE GRINDING



- White
- Silver
- Black

CGFL250



Rotary Adjustment Dial



Professional Precision Version



Professional Precision Version

Model	CGFL250
Power	250W
Volt/Frequency	220-240v 50/60Hz
Dimension	306*123*360mm
Bean hopper capacity	50g
Burr size	64mm(flat)
Speed	600-1800RPM



- White
- Silver
- Black

CGFL250



Front-mounted separate structure



Adjustable magnetic base



Quick-release structure design

Model	CGFL250
Volt/Frequency	220V~ 50Hz
Dimension	380*210*310mm
N.W.	6/5KG
Bean hopper capacity	50g
Burr size	64mm(flat)
Speed	600-1812





IT-CG48

HOUSEHOLD COFFEE GRINDER



• 48mm integrated CNC outer knife plate



PRODUCT FEATURE



Mute grinding



Aluminum body



Easy to disassemble and clean



Coffee powder particle size can be infinitely adjusted

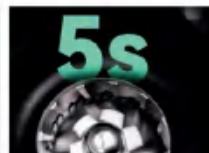

Close after 5 seconds



Prevent slide at the bottom



Start key

Model	IT-CG48
N.W.	2KG
Dimension	235*98*65mm
Burr size	48 mm



ELECTRIC BEAN GRINDER



CBG150-1



CBG150-2



PRODUCT FEATURE

- The inlet is less than 12MM.
- When the adjusting component is detached from the main machine, the machine will automatically stop rotating.



- ON/OFF
STARTGRINDING



- Fine steel grinding core high-precision grinding and more efficient



Model	CBG150-1	CBG150-2
Power	72W (load power 150W)	
Motor	24V 140 -rpm High -Power Torque Silent Motor	
Adapter	24V 3A (load power 150W)	
Dimension	118*103*260mm	
N.W.	1.8KG	
Packing size	357*216*123mm	
G.W.	2.3KG	
Hopper capacity	18g	
Burr	SS420/Dia.48mm conical type	



ELECTRIC BEAN GRINDER

CGB150-5



Manual residual powder cleaning



Magnetic bean hopper cover

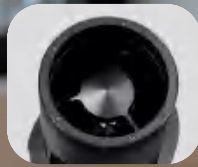

Anti-bean-jump cover



Model	CBG150-5
Power	72W (load power 150W)
Motor	24V 140 -rpm High -Power Torque Silent Motor
Adapter	24V 3A (load power 150W)
Dimension	118*103*260mm
N.W.	1.8KG
Packing size	357*216*123mm
G.W.	2.3KG
Hopper capacity	18g
Burr	SS420/Dia.48mm conical type



One-piece seamless grinding chamber



Vertical powder dropping design





IT-03

ELECTRIC COFFEE GRINDER

PRODUCT FEATURE

- Base Material: High Nitrogen 420 Stainless Steel
- Maximum Continuous Grinding Time: 60 Seconds Grinding Time + 90 Seconds Rest
- Magnetic suction device: magnetic cup seat/powder cup/bean warehouse cover
- Automatic sensor: One -click turning on the grinding automatic broken electricity



Model	IT-03
Volt/Frequency	100-240V
Power	100W
N.W.	4.7KG
Dimension	147*90*310mm
Burr size	48mm 6-Core Conical Burr (Inner Diameter 38mm)





ITOP40 PLUS V1/V2

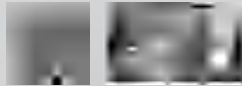

ELECTRIC COFFEE GRINDING

PRODUCT FEATURE

- Magnetic powder cup attachment
- Multi-level grind size adjustment
- Double-layer air pressure pump design, press twice after grinding to easily discharge the residual powder inside, easy to clean the powder.
- Optional 64mm flat burr / 63mm conical burr
- Coffee machine burr



- Adjustable speed/timing grinding



Cone burr - adjustable 300-800R/MIN
Flat burr - adjustable 600-1500R/MIN

- White
- Black



TECHNICAL DETAILS

Model	ITOP40 plus V1	ITOP40 plus V2
Volt	220-240V/50Hz	220-240V/50Hz
Power	250W	250W
N.W.	5KG	5KG
Dimension	230*130*400mm	230*130*400mm
Burr size	63 mm (conical burr)	64 mm (flat)
Grind speed	300 - 800 R / MIN	600 - 1500 R / MIN



Coffee Bean Grinder

Our hot-selling style: ITOP 40, ITOP 40 plus, DM47



ITOP 40



ITOP 40 Plus



DM47

Product Model	ITOP40	ITOP40 Plus	DM47
The sales situation on AliExpress	 ITOP Electric Coffee Grinder 40MM Titanium Burr Metal... Orders(1564)	 ITOP40 Plus Coffee Grinder Upgrade-64MM Flat Titanium... Orders(369)	 ITOP Coffee Grinder 47mm Conical 420 Stainless Steel... Orders(339)
Burr Size	40mm	64mm	47mm
Burr Type	Conical Burr	Flat Burr	Conical Burr
Burr Material	Titanium	Titanium	High Nitrogen Steel
Power	180W	250W	—
Speed	600r/min	1200r/min	120r/min
Dial Adjustment	Holes Location	Stepless	Stepless
Hopper Capacity	75g/180ml	75g/180ml	Single Dose up to 30g
Motor Type	150W DC Motor	250W DC Motor	775 DC Geared Motor
Fineness Adjustment			
Machine Weight	2.6kg	5kg	2.65kg
Machine Size	9.6*17.4*31cm	13*22.5*41cm	9*17*23cm
Remarks	Hot sale in Korea Market, up to 1600pcs in 3 months.	Three types of burrs to choose  For multifunctional For Pourover For Espresso	The Burr learn from KINU® The package contains car power socket, can use the machine by car cigarette lighter



63MM GHOST TOOTH HAND GRINDER

CGSY63Z



PRODUCT FEATURE

- 63 Ghost Tooth Conical Burrs, Fixed Manual Grinder. The large conical burrs effectively expand the grinding area, taking about 40 seconds to grind 18g of beans for espresso.
- Air-Blower Bean Hopper: Reduces residual grounds and enables easy cleaning.
- Large-Diameter Bean Hopper.
- External Adjustment Dial.



Ergonomic handle



Air blowing bean bin



Magnetic suction down powder bin
Magnetic powder outlet



External adjustment dial

Model	CGSY63Z
Dimension	230*240*400mm
N.W.	6.7KG
G.W.	7KG
Blade size	63mm Ghost tooth conical burr
Grinding speed	Grinding 18g in 30 seconds



MANUAL COFFEE GRINDING



IT-HG48



Exterior grind adjustment setting
0-72 grid adjustable



Model	IT-HG48
N.W.	0.85KG
Dimension	60*60*90mm
G.W.	0.9KG
Packing size	280*190*90mm
Burr size	38mm/48mm(cone)
Housing material	Aluminum Alloy



IT-HG50



Iron-plated ghost-tooth burr



Titanium-plated flat burr

Ghost-tooth flat burr interchangeable



Handles: 304 stainless steel + solid wood handle



Color

Model	IT-HG50
N.W.	0.845KG
Dimension	61*61*178mm, 170mm(handles)
Burr type	Ghost-tooth/Flat burr
Cavity capacity	40g





IT-CG-Y1

HAND GRINDER

- 40MM ghost tooth cone cutter
- Integrated aluminum alloy body
- Multi-stage fine grinding



Model	IT-CG-Y1
Capacity	Bean hopper 45g + powder hopper 30g
Material	Stainless steel/aluminum/wood
Burr	40MM Conical burr with ghost tooth
N.W.	845g

PRODUCTS



2-IN-1 PORTABLE COFFEE MACHINE

IT-CM-BXS2

PRODUCT FEATURE



- Low-noise operation: Below 50dB
- Compact and portable
- Fast heating: Cold water only needs 3-5 minutes for heating



Model	IT-CM-BXS2
Power	140W
Voltage	DC 12V
Dimension	72*72*210mm
N.W.	0.75 KG
Built-in battery capacity	9000mAh
Water filling capacity	90ml
System pressure	15 bar



Extraction System



Can heat cold water to 92°C



AUTOMATIC TAMPING COFFEE GRINDER

CMAL1300

PRODUCT FEATURE

- One-Touch Bean Grinding – Resistance Sensing in the Hopper for Automatic Stop After Grinding
- 7 Grinding Levels – External Rotating Ring for Fineness Adjustment, Catering to Various Coffee Flavor Preferences
- Foldable Precision Filter – Blocks Tiny Coffee Grounds, Enabling Easy Brewing of Aromatic Coffee



Foldable Filter Hanging Ear



Precision Fine-Mesh Filter



Ceramic Grinding Core Milling



External Adjustment Gears



Model	CMAL1300
Charging voltage	5V
Battery voltage	3.7V
Charge current	1A
Dimension	80*80*252mm
Battery capacity	1300mAh



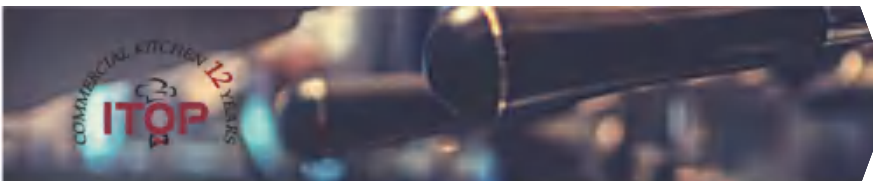

<https://youtu.be/sGA4kFVym2Q>



Electric Stand for Manual Coffee Grinder

Compatible with most hand grinders.

Brand: ITOP
Model: IT-MGSKM
Product Name: Hand grinder Grinding support
Voltage: 24V (built-in lithium battery 3000mAh)
Power: about 80W
Button force: about 180KG
Grinding speed: support 50-300RN variable speed adjustment
Material: aluminum alloy/PV
Weight: net weight about 2.6KG

Detachable fixed bracket

Variable speed adjustment

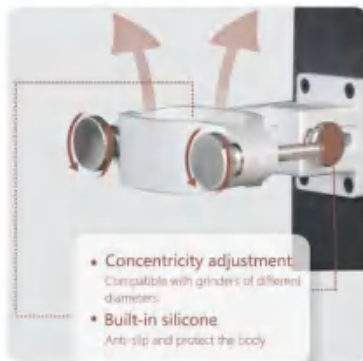

Charging version / Plug-in version

Hexagon shaft + magnetic accessories





IT-POK



HOUSEHOLD ELECTRIC POUR-OVER KETTLE



• Certified cable and plugs



US

UK

EU

customized

Model	IT-POK
Volt	220-240V
Power	1000W
Capacity (ml)	600ml /1000ml
Boiling time	5 to 6 minutes (with 1.L water,ambient temperature 26 °C)
Temperature control range °C	104-208-212°F
Temperature control range °F	40-98-100 °C (Celsius Fahrenheit changable)
Rapid boil funtion	Yes, it boils to 100 degree



SEMI-AUTOMATIC COFFEE MACHINE

KFJ52QC



Model	KFJ52QC
Power	2650W
Volt/Frequency	220V/50Hz
Dimension	380*210*310mm
N.W.	16KG
Packing size	290*300*380mm
Coffee boiler	0.52L
Water tank	3L

PRODUCT FEATURE



0.52L high efficiency boiler



Integrated LCD touch screen
Extraction is so simple



OPV External adjustable OPV



COMMERCIAL COFFEE MACHINE

IT-CM6008

PRODUCT FEATURE

- Independent dual boiler system: Extraction, steam, and hot water functions are mutually unaffected.
- 1.2L stainless steel water storage steam boiler: Delivers rapid and powerful steam.
- 3-hole steam wand: Adjustable steam temperature with intelligent temperature-set milk frothing.
- 15Bar extraction pressure and 58mm commercial thermostatic brewing group.
- Automatic low-pressure pre-infusion system: Adjustable extraction time for single and double cups.
- Automatic pressure relief safety protection to ensure extraction quality.
- Independent hot water outlet with honeycomb design: Smooth water flow without splashing.
- Equipped with automatic water inlet and outlet, also switchable to 2.5L water tank for water supply.



Model	IT-CM6008
Power	2800W
Volt/Frequency	220V-240V / 50Hz-60Hz
Dimension	400*322*430mm



Independent dual boiler system



3-Hole steam wand



58mm Commercial thermostatic brewing group



Automatic low-pressure pre-infusion system

ESPRESSO COFFEE MACHINE

CMKM2950

PRODUCT FEATURE

- Dual thermo block
- Dual electromagnetic pumps
- Professional brewing group head 58mm
- Sliding switch for extraction
- Electric steam switch
- Single / Double cup extraction switch
- Supports independent 3.5L water tank and external water supply



Model	CMKM2950
Power	2950W
Volt/Frequency	220-240V~, 50/60Hz or 110-120V~, 60Hz
Dimension	446*230*332mm
N.W.	12KG
Bean hopper capacity	525*320*460mm
G.W.	16KG
Water tank capacity	3.5L



SINGLE-EXTRACTION COFFEE MACHINE

CMSB1400

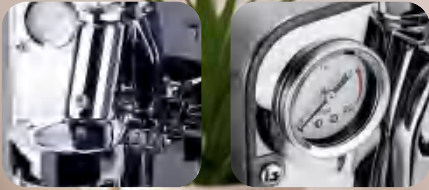

Classic E61 brewing group

Extraction pressure gauge

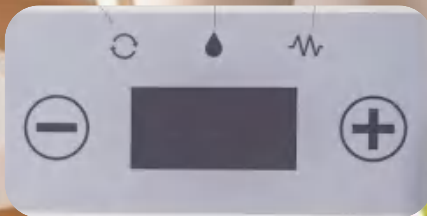

Simple display screen



Model	CMSB1400
Power	1400W
Volt/Frequency	110/230V 50Hz
Dimension	215*390*340mm
N.W.	13KG
Packing size	220*400*325mm
G.W.	14.5KG
Boiler capacity	800mL
Pressure	0-15bar
Pump type	Vibrating pump
Water supply mode	Bottled water

- **LExternal glass water tank**
2L Large-capacity water tank
Convenient for carrying and outdoor use



<https://youtu.be/obFmfx2UJ4c>

SEMI-PROFESSIONAL ESPRESSO COFFEE MACHINE

Double boiler And Double pump performance

Integrated Grinder Coffee Machine, the Top Choice for Home Use



Dual boiler system



Dual water pump



20bar extraction



PID temp-controller



Pre-soaking



58mm excellent brew



Voltage: 220-240V, 50/60Hz

Extraction pressure: 20Bar

Bean box capacity: 250g

Water tank capacity: 3.0L

Rated Power: 2800W, with pressure gauge

Housing: Brushed Stainless Steel housing, with LED display

Double pump system: 20bar coffee system +5 bar heating & steam system

Double boiler structure: 1500w coffee boiler + 1300w steam boiler, shorten the waiting time

Machine size: 395 mm*310mm*398 mm

Unit weight (kg): 12.8kg

Packing per master carton: 1 pcs

Packing per giftbox: 1 pcs

MOQ: 1*40HQ



15 section thickness adjustment, precise fine-tuning, to meet different brewing needs.

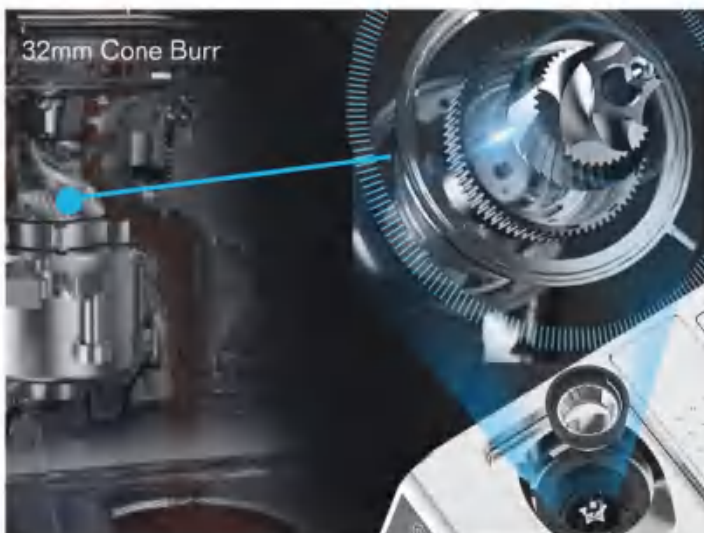

ESPRESSO COFFEE MACHINE



IT-ATC-18

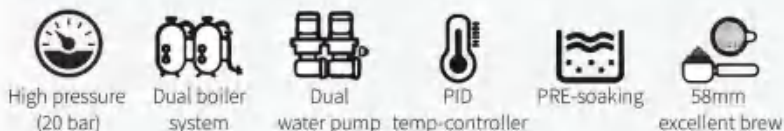

- Conical grinder grinds with 15 grind settings (capacity: 250g)
- Active temperature control with dual heating system
- 20 Bar High Pressure Extraction
- Cup warmer function
- Simplified modern touch screen control design

Model	IT-ATC-18
Volt/Frequency	110V
Power	2500-3050W
Dimension	395*310*398 mm
Water tank capacity	2.7L Detachable Water Tank
Bean box capacity	250g



Stainless steel drip tray
Removable for easy cleaning



Removable coffee Bean box



IT-ATC-14

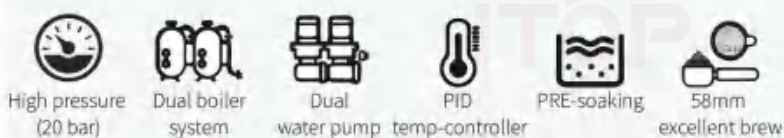

- Conical grinder grinds with 15 grind settings (capacity: 250g)
- Active temperature control with dual heating system
- 20 Bar High Pressure Extraction
- Cup warmer function
- Simplified modern touch screen control design

Model	IT-ATC-14
Volt/Frequency	110V
Power	2500-3050W
Dimension	395*310*398 mm
Water tank capacity	2.7L Detachable Water Tank
Bean box capacity	250g

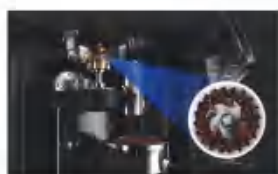

Cone knife sharpener Stainless steel cone sharpener, low grinding heat, even coffee powder thickness



Low pressure pre-soak system Bring out the rich flavor of the coffee beans



COMMERCIAL COFFEE MACHINE

IT-CM6005



PRODUCT FEATURE



Professional Pressure Gauge



Extended Steam Pipe



LCD Display Screen



Independent Hot Water Outlet

- **Dual Pump & Triple Heating Module:** coffee and steam are carried out simultaneously



Model	IT-CM6005
Power	3100W
Volt/Frequency	220-240V/50-60Hz
Dimension	310*340*420mm
N.W.	11.5KG
Pump Pressure	15Bar

COMMERCIAL COFFEE MACHINE

CMSM3000B



PRODUCT FEATURE

- LED touch screen allows setting of extraction and steam temperatures, as well as pre-infusion time.
- PTC Constant Temperature Brewing Head
- Equipped with imported rotary pump and imported solenoid valve for longer machine lifespan.
- Independent boiler design shortens heating time and improves extraction efficiency.
- Effortlessly copes with a daily output of over 200 cups

Model	CMSM3000B
Power	3200W
Volt/Frequency	220V / 50Hz
Dimension	620*420*500mm
N.W.	30.5KG
Extraction boiler	1L/1000W
Steam boiler	3L/2200W



Home semi-automatic coffee



Model: IT-CM-M1

Model: IT-CM-M2

Specification

Product specifications:	220V 50Hz	220V 50Hz
Product power:	1450W	2800W
Product size:	285x340x370mm	285x340x370mm
Boiler:	Single pump single boiler	Double pump double boiler
Color:		

Commercial system

Accurate temperature detection
Industrial Grade NTC Sensor
Stable pressure supply
Impacted vibration pump

Boiler/Technology

Double instant or hot pot
Segmented heating mode, efficient, continuous and stable
Water temperature and steam are more stable



58mm
extraction



15Bar
+ booster pump



Pre-soaking
system



Three-hole
steam nozzle



Model: IT-CM-D1

Specification

Product specifications:	220V 50Hz
Product power:	3000W
Product size:	350x380x370mm
Boiler:	Two pumps and three boilers
Color:	

Commercial system

Accurate temperature detection
Industrial Grade NTC Sensor
Stable pressure supply
Impacted vibration pump
Accurate traffic
High-precision impacted flow meter controls flow

Boiler/Technology

Composite brewing head, multiple boiler systems
Segmented heating mode, efficient, continuous and stable
2.5L steam combined boiler



Model: IT-CM-S1

Specification

Product specifications:	220V 50Hz
Product power:	2800W
Product size:	340x410x380mm
Boiler:	0.5L coffee boiler + 0.8L steam boiler
Color:	

Commercial system

Accurate temperature detection
Industrial Grade NTC Sensor
Stable pressure supply
Impacted vibration pump
Accurate traffic
High-precision impacted flow meter controls flow

Boiler/Technology

Composite brewing head, multiple boiler systems
Segmented heating mode, efficient, continuous and stable
2.5L steam combined boiler





IT-CM-S1

HOUSEHOLD COFFEE MACHINE



White Black Silver

PRODUCT FEATURE



58mm
extraction



9bar imported
water pump



Import
flowmeter



PID intelligent
temperature control



LED LCD
display



Pre-soaking
system



Exchanger
boiler



Four-hole steam
nozzle head







Model	IT-CM-S1
Volt/Frequency	220V 50Hz
Power	1660W
Dimension	340*410*380mm



SEMI-AUTOMATIC ESPRESSO MACHINE



CMDR2250

- 
LED touch screen
- 
58mm extraction
- 
Dual water pump
- 
Adjustable pre-infusion function
- 
Three-hole steam nozzle head
- 
Stepless Variable Pressure Extraction

Efficient dual boilers, precise extraction

- 1000ml powerful steam boiler with precisely adjustable boiler temperature
- Equipped with a coffee pressure gauge, the extraction pressure can be easily seen
- External detachable water tray for convenient cleaning
- Equipped with a large-capacity 1000ml steam boiler and 600ml coffee boiler

Model	CMDR2250
Power	2250W
Volt/Frequency	220V/50Hz
Diameter	350*426*370mm
Extraction boiler capacity	1000ml
Water tank capacity	600ml

CMDR2350

- 
LED touch screen
- 
Food-grade stainless steel boiler
- 
58mm extraction
- 
Pre-soaking can be customized
- 
PID intelligent temperature control!
- 
Stepless Variable Pressure Extraction

Multi-function, fast, easy-clean

- Features hot water production function
- Lever-type self-resetting hot water and manual steam functions
- High-efficiency instant heating system for simultaneous extraction and milk steaming
- Coffee pressure gauge: real-time visible extraction pressure
- External detachable water tray with automatic drainage via connected pipe for easy cleaning

Model	CMDR2350
Power	2350W
Volt/Frequency	220V/50Hz
Diameter	337*391*494mm
Extraction boiler capacity	550ml
Water tank capacity	1000ml





IT-CM-850

ITALIAN SEMI -AUTOMATIC COFFEE MACHINE



Touch -type adjustment panel



PRODUCT FEATURE



540cc
copper boiler



Visualized semi -extended
saturated rushing head



Adjustable
pre -soaking



Adjustable extraction
water temperature



External OPV voltage
pressure device



New temperature
control system



3 hole nozzle

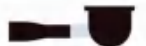

58mm solid
wood handle



COFFEE/BEVERAGE EQUIPMENT

COFFEE MAKER



- Plastic housing with S/S decorative sheet
- Touch electronic button
- LED illuminator
- Barometer for pressure understand
- Whole S/S filter holder
- 58mm diameter S/S filter
- Pre-infusion system
- S/S steam and water pipe
- Removable drip tray & Anti-slip foot
- Top cover cup-warming plate



NO.	1	2	3	4
Model	IT-MT19-M3	IT-CM750	IT-CM2550	IT-MT-30
NO.	5	6	7	8
Model	IT-MT-30A	IT-CM2700	IT-MT183	IT-MT19-M2





IT-SCM-E61B

COMMERCIAL COFFEE MACHINE

PRODUCT FEATURE

- Professional coffee brewing head, weighing 4.2kg; manual tie-type coffee
- The shell uses 304 mirror panel
- Use a microcomputer one-click switch, automatic water automatically heating, comes with anti-drying function
- External air pressure meters and water pressure meters, display and adjust the required pressure
- The built-in boiler capacity is 5 liters, directly connect to the external water source



White
 Black

Model	IT-SCM-E61B
Volt/Frequency	220V 50Hz
Power	2000W
N.W.	32KG
Dimension	329*476*426mm
Boiler capacity	5L
Pump	Rotary pump



E61 COFFEE MACHINE



CMKX2200



Pre-soaking system



9bar imported water pump



Four-hole steam nozzle head



Exchanger boiler



Classic E61 bubble head



Coffee pressure gauge



PID intelligent temperature control



58mm stainless steel professional handle

Model	CMKX2200
Volt/Frequency	220-240V , 50-60Hz
Power	2200W
Dimension	259*420*478mm



IT-ES-612



Pre-soaking system



Overheating, overvoltage protection



Four-hole steam nozzle head



Exchanger boiler



Classic E61 bubble head



OPV valve



PID intelligent temperature control



58mm stainless steel professional handle

Model	IT-ES-612
Volt/Frequency	220-240V , 50-60Hz
Power	2050W
N.W.	21.5KG
Dimension	290*375*455mm
G.W.	27.5KG
Packing size	516*386*573mm



E61 BREWING GROUP COFFEE MACHINE



TATTAHOME



are also selling it

OUR MACHINE
PICTURE



Product Name

Commercial semi-automatic
coffee machine

Commercial semi-automatic
coffee machine

Model

IT-SCM-E61

IT-SCM-E61B

Voltage

220V/50Hz

220V/50Hz

Power

1800W

2000w

Boiler Capacity

2.2L+1.2L

5L

Color

Vintage classic style

White/Black

Pump

Rotary

Rotary pump

Machine Size

310*510*410mm

329*476*426mm

Weight

25kg

32kg



SEMI-AUTOMATIC ESPRESSO MACHINE



CMKE2300

- Made of 304 stainless steel with a painted surface; it has a built-in suction and water circulation system as well as a water volume measurement system to maintain stable water pressure at all times.
- Mother-child / dual boiler design for stable water and steam output.
- Automatic air supply system equipped with a button for continuous water discharge.
- PID precise temperature control system, stably supplying water pressure of 9-15 bar and water temperature of $90 \pm 5^{\circ}\text{C}$.
- E61 brew group with an adjustable pressure range of 3-15 bar, featuring a 4-hole steam wand and a single water outlet, plus dual-spout extraction for serving.

Model	CMKE2300
Power	3200W
Volt/Frequency	110/ 230V 50Hz
Diameter	478*500*458mm
N.W.	30KG
Packing size	580*470*600mm
G.W.	33KG
Boiler capacity	0.8/1.3L
Brewer type and size	E61 58mm

CMMN3750

PRODUCT FEATURE

- Stainless steel boiler system, steam and coffee brewing are separated.
- 2-3 boilers of boilers for boilers
- Capacity control system with continuous brewing button.
- Electric heating element with overheat protective switch.
- Pressure protection system.
- Stable 9 strokes, $90 \pm 5^{\circ}\text{C}$.
- 2-3 sets of bubbles, 1 water belt, 2 steam jets.
- The cup heating platform includes Direct to high paper cup.

Model	CMMN3750
Power	CMMN3750
Volt/Frequency	110/ 230V 50Hz
Diameter	665*560*580mm
N.W.	68KG
Packing size	883*688*682mm
G.W.	88KG
Boiler capacity	11L
Brewer size	58mm



IT-CM-850



White Black Wooden

IT-CM2700



White Black Wooden

IT-MT-30



White Black Wooden

IT-CM2550



White Black Wooden

Model	IT-CM-850	IT-CM2700	IT-MT-30	IT-CM2550
Volt/Frequency	220V/50Hz	220V/50Hz	220V/50Hz	220V/50Hz
Power	2550W	1200W+1500W	2550W	2550W
Pressure	15 bar	15 bar	9 bar	9 bar
N.W./G.W.	20.4KG / 25KG	20KG / 22KG	38KG / 40KG	40KG / 45KG
Dimension	340*340*460mm	320*340*480mm	340*470*500mm	520*410*420mm
Packing size	460*430*520mm	360*490*520mm	360*490*520mm	700*600*500mm
Water tank capacity	3L	3.8L		
Copper Boiler capacity	540CC	520CC ^{+steam} heating block	750+200CC	1000+3200CC
Material	S/S 304#			



COMMERCIAL COFFEE MACHINE



IT-CM-MG1



Model	IT-CM-MG1
Volt/Frequency	220V 50Hz
Power	3400W
Dimension	396*546*455mm



IT-CM-O1



Model	IT-CM-O1
Volt/Frequency	220V 50Hz
Power	2400W
Dimension	396*546*455mm



SEMI-AUTOMATIC ESPRESSO MACHINE



CMHT5000



CMSM3000



LED touch screen



Precision extraction



Dual-pressure display



Steam extraction



Standard flow rate



Milk-coffee dual system



Food-grade stainless steel boiler



30-98°C Adjustable extraction temperature

PRODUCT FEATURE

- LED touch screen allows setting of extraction and steam temperatures, as well as pre-infusion time.
- Full copper heat-exchange brewing head maintains temperature using steam heat.
- Equipped with imported rotary pump and imported solenoid valve for longer machine lifespan.
- Independent boiler design shortens heating time and improves extraction efficiency.
- The new heat exchange group offers longer heat retention, maintaining the ideal temperature for Golden Cup extraction
- **New Heat-Exchange Brewing Group, with Longer Heat Retention, Maintaining the Ideal Temperature for Golden Cup Extraction**

Model	CMHT5000	CMSM3000
Power	3200W	3000W
Volt/Frequency	220V / 50Hz	220V / 50Hz
Dimension	620*420*500mm	620*420*500mm
N.W.	30.5KG	30KG
Extraction boiler	1L/1200W	1L/1200W
Steam boiler	3L/2200W	3L/2200W



COMMERCIAL COFFEE ROASTING SMOKE FILTER

CBLY107



PRODUCT FEATURE

- Efficient purification, environmentally friendly.
- Cooking fume purification efficiency up to 95%.
- Strong pollution resistance and stable adsorption effect.
- Safe, stable and highly durable.
- IP55 dustproof and waterproof rating, double door open power-off protection, oil drain port design, ensuring operation and equipment safety.
- Intelligent, convenient and highly adaptable.

Model	CBLY107
Power	106.7W
Dimension	510*545*525mm
Air Inlet size	359*287mm
Air resistance	60pa
Oil drain port	1 Inch



- **Electrostatic Purification Principle**
Pre-filtration + High-efficiency Purification + Deep Purification



INTELLIGENT SEMI-AUTOMATIC COFFEE MACHINE

CMKF4200

- White
- Silver



PRODUCT FEATURE

- 3-Hole Steam Wand for Quick Milk Frothing
- Low-Temp High-Pressure Pulsed Cold Brew, Instant Serving
- Deep Cleaning Programs: Group Head Backflushing, Steam Wand Cleaning, Descaling
- Group Head Ambient Light: Orange Breathing (During Hot Brew Extraction) | Blue Breathing (During Cold Brew Extraction) | Red Breathing (In Alarm Mode) | White Breathing (During Cleaning)



7-inch flip screen



Professional 64mm metal flat blade



Bean Hopper

Upper Blade Disk

- The bean hopper and upper blade disk are detachable.

Model	CMKF4200
Power	2000W
Volt/Frequency	220V~50Hz
Dimension	333*419*377mm
N.W.	12.5 KG
Bean hopper capacity	250g
Water tank capacity	2L





Our factory tour



IT-CM808

COMMERCIAL COFFEE MACHINE



PRODUCT FEATURE

• Independent Boiler System



Independent coffee extraction boiler, steam boiler, Hot water boiler

• Automatic pre-soaking function

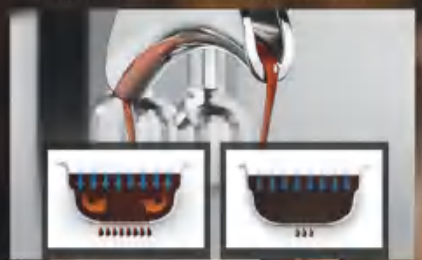

• Product Details



Extraction pressure gauge Omnidirectional steam regulating lever

Model	IT-CM808
Volt	220V, 50Hz
Power	3500W
N.W.	18KG
Dimension	408*321*515mm
Packing size	530*396*586mm
Water tank capacity	3.8L
Extraction handle	58MM

Hot seller in Southeast Asia, the king of cost-effectiveness at the entry level

- Three-hole steam nozzle head
- PID intelligent temperature control
- Multi-boiler system
- Omnidirectional steam regulating lever
- Automatic pre-soak system
- Imported Ulka pumps
- 58mm bakelite handle

+86 159 1313 1991
export@itopkitchen.cn





COFFEE MACHINE



IT-CM808



Three independent heating furnaces



Imported Ulka Pumps



Omnidirectional Steam Regulating Lever



Pid Temperature Control Technology



Automatic Pre-Soak System



Adjustable 3-Hole Steam

Model	IT-CM808
Voltage	220V/50Hz
Power	3500W
N.W.	18kg
Water tank capacity	3.8L
Output	50 Cups/Hour
Machine size	408*321*515mm

Optional:

IT-CM808B	1.2L S/S boiler for hot water and steam
IT-CM808C	Remove steam and hot water functions, retaining only the extraction function.

- Self-contained drainage;
- Stainless steel & Plastic side cover;
- Electronic button for easy operation;
- Italian pump with 15bar pressure;
- A 1500W heating block for making coffee;
- Two are thermo-blocks for making hot water and steam;

- 3.8L Removable water reservoir;
- With a barometer, can know the pressure when making coffee;
- Professional s.s. porta-filter holder and filter with 58mm diameter;
- S.S. steam and water pipe for cappuccino and hot water;
- Removable drip tray for easy cleaning; also can connect drain pipe directly;
- Top cover cup-warming plate & Adjustable non-slip foot;

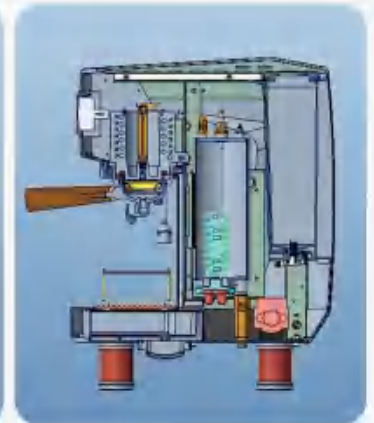
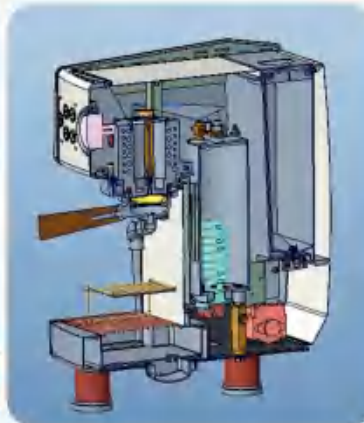

COMMERCIAL COFFEE GRINDING

IT-CG-64SC



White
 Black

Model	IT-CG-64SC
Power	350W
Volt/Frequency	220V~50Hz
Dimension	252*478*208mm
N.W.	8.7KG
Bean hopper capacity	500g

PRODUCT FEATURE

- Uniform and concentrated powder output: No powder flying, no clumping, low noise and fast powder dispensing.
- Weighing quantitative grinding: Built-in electronic scale with a weight error of $\pm 0.2g$, also switchable to time-based quantification.



Precision-Controlled
64MM titanium-plated
cutter disc



0-8 Gear infinite
stepless fine tuning



Touch screen operation



Easily adjustable metal
stand



Non-Slip pad & anti-
vibration design



<https://youtu.be/sGA4kFvym2Q>



Product Name	Commercial Coffee Grinder			
Model	CG-022	CG-020	IT-CG-601	IT-CG-027
Grinding Stones Diameter (Flat type) :	60MM			
Hopper Capacity :	500G/1000G	1000G	200G/250G	250G
Motor Speed :	2000 RPM		1000 RPM	
Voltage/Frequency	220V/50Hz, 110v/60Hz			
Gross Weight :	5.5KG		5.51KG	5.5KG
Product Size :	22×14×47CM			
Packing Size:	42×19×31.5CM (1PCS) 44×41.5×33.5CM (2PCS)		45×33×41.5CM (2 PCS)	36×16×26CM (1 PCS) 37×64×27CM (2 PCS)
Power :	200W	250W	300W	200W
Body Material :	Cast Aluminum alloy		Plastic	Cast Aluminum alloy
Drive Way :	Touch Panel	On Demand	Semi-Automatic	
Available Colors :	Black / Creamy White	Black /White	Black / White	Black / White
Burrs :				



<https://youtu.be/sGA4kFvym2Q>



Product Name	Commercial Coffee Grinder		
Model	IT-ACG360	IT-MCG360	IT-SCG350
Grinding Stones Diameter (Flat type) :	64MM		
Bean Hopper Capacity :	1.5L		
Rpm :	1450		
Voltage/Frequency	220V/50Hz, 110v/60Hz		
Gross Weight :	14.5KG	13.5KG	14.5KG
Product Size :	40×25×59CM		
Packing Size:	60×26×40CM		
Power :	360W		350W
Drive Way :	Automatic	Manual	Semi-Automatic
Available Colors :	Black / Red / White	Black / Red / White / Silver	Black / White

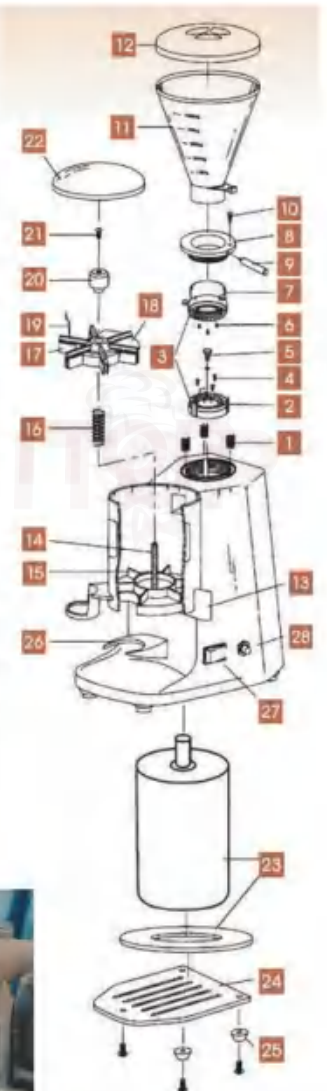

ELECTRIC COFFEE GRINDING



White Black Silver Red

CG-800

TECHNICAL DETAILS

Model	CG-800
Volt/Frequency	110-240V, 50-60Hz
Power	350 W / 1400 rpm
N.W.	11KG
Dimension	300*210*560mm
G.W.	14KG
Burr Size	Φ 64 mm (flat)
Crushing force (Smash Ability)	7-12 kg/hour

ITOP40 PLUS



• Three types of burrs to choose



• Fineness adjustment



TECHNICAL DETAILS

Model	ITOP40 Plus
Power	250 W
N.W.	5KG
Dimension	130*225*410mm
Burr Size	64 mm (flat)
Burr Material	Titanium
Operating speed	1200r/min
Bean container capacity	75g/180ml



ELECTRIC COFFEE GRINDER



PRODUCT FEATURE



Anti-flying powder device



The cutter head can be lifted or lowered in one turn by 1mm



Press and hold for 25s to adjust the grinding time



Tighten the scale to return to zero



Magnetic base



Burri diameter 74mm



OLED display without hole

Model	IT-CG74		
Volt	220v	Power	500W
N.W./G.W.	3KG/4KG	Dimension	245*120*295mm
Burr size	74 mm (flat)	Bean container capacity	50g
Operating speed	600-1500r/min	Meterail	Al



ELECTRIC COFFEE GRINDER



White Black

CGAGM250

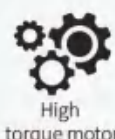
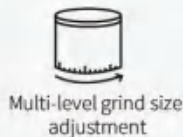
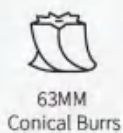

TECHNICAL DETAILS

Model	CGAGM250
Volt	DC24V
Dimension	184*88*289mm
N.W.	≈ 3.4KG
G.W.	6KG
Burr size	63MM Conical Burrs (Mazzer Burr Compatible)
Bean container capacity	45G
Motor speed	350RPM



CGTB1500

PRODUCT FEATURE

- 1500W motor with 10Nm torque, easily handles extremely lightly roasted beans
- Replaceable burrs: 80mm, 98mm, and 102mm magnetic blind burrs & perforated burrs (burr size changes require replacing the burr mounting base)
- Anti-static design to prevent powder flying
- Grinding precision up to 0.02mm

TECHNICAL DETAILS

Model	CGTB1500
Volt/Frequency	220V,50/60Hz,10A
N.W.	12KG
Dimension	255*155*350mm
Packing size	410*410*215mm
Burr size	80mm,98mm,102mm
Bean container capacity	20-30g
Motor speed	50-1800RPM



COMMERCIAL COFFEE GRINDING



• IT-GT64

• IT-GT64-V

IT-GT64/GT64-V



64 mm (flat)

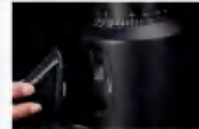

Magnetic powder outlet



Multi-level grind size adjustment



Adjustable speed knob



Model	IT-GT64	IT-GT64V
Volt/Frequency	220V/50Hz	220V/50Hz
Power	300W	300W
N.W.	7.5KG	7.5KG
Dimension	130*210*320mm	130*210*320mm
G.W.	8.5KG	8.5KG
Packing size	300*410*170mm	300*410*170mm
Burr size	64 mm (flat)	64 mm (flat)
Bean hopper capacity	50g	50g
Motor Speed	1400 RPM	800-2000 RPM

IT-CG-YF35



58 mm (flat)



Multiple ventilation holes design



Button switch



14 Levels Grinding Adjustable

Model	IT-CG-YF35
Volt/Frequency	220V/50Hz
Power	50W
N.W.	3.4KG
Dimension	280*100*310mm
G.W.	4.2KG
Packing size	410*395*140mm
Burr size	58 mm (flat)
Bean hopper capacity	80g



HAND PRESS COFFEE MACHINE



IT-CM-ML16



304 Stainless steel
CNC processing

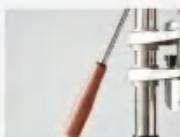

Wood handle

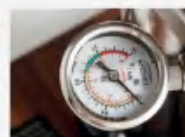

Pressure gauge



Detachable design

Model	IT-CM-ML16
N.W.	8KG
Dimension	200*300*580mm
Cavity capacity	100ml
Extraction pressure	1-16bar

IT-HPEM-2



58mm



standard coffee handle



Pressure gauge



304 Stainless steel
CNC processing

Model	IT-HPEM-2
N.W.	10KG
Dimension	200*380*440mm
Cavity capacity	100ml
Extraction pressure	1-16bar

COMMERCIAL INTELLIGENT TEA MAKING MACHINE

IT-CTM-5



- 7-inch color operating display screen
- Mixing through gear drive
- Safety lock to prevent misoperation
- Double layer anti-scalding design
- Photoelectric detection prevents hidden dangers of forgetting to put the tea bucket

Model	IT-CTM-5
Volt/Frequency	220V 50Hz
Power	3300W
N.W. / G.W.	25KG /29.2KG
Dimension	625*276*831mm
Boiling water tank capacity	10L
Tea brewing capacity	1-5L

IT-ITBM5L



- Intelligent system, water in, tea brewing, tea out automatically completed.
- Digital operation menu to ensure standard parameters.
- Patented tea net, tea leaves are fully stretched.
- Independent touch keys, flexible control.
- One key automatic cleaning, clean and sanitary.

Model	IT-ITBM5L
Volt	220V
Power	3000W
Dimension	260*510*680mm
G.W.	18.5KG
Package size	325*605*755mm
Boiling water tank capacity	9L
Tea brewing capacity	5L

IT-CTM-10



- 7.0-inch Android smart screen
- 6 sets of DIY menu, Customized adjustment of tea brewing parameters according to different tea types.

Model	IT-CTM-10
Volt/Frequency	220V 50Hz
Power	3.5KW
Dimension	260*560*780mm
Boiling water tank capacity	10L
Tea brewing capacity	5L



DISTILLING COFFEE MACHINE



- Stainless steel coffee machine - with two carafes

Product model: IT-ND1000
Water tank capacity: 1.8L;
Body Material: 304 stainless steel;
Power: 1600W
Voltage: 220V-240V
Brewing time: 6 - 7 minutes;
N.W.: 6.4kg;
G.W.: 7.36kg;
Product size: 21.5*38.5*46 cm;
Packing size: 42.5*24.5*51 cm;



- With two 1.8L glass pots;
- With 2 glass jugs imported from BUNN USA;
- Stainless steel funnel;
- Plastic water inlet;

Product model: DCM-288
Water tank capacity: 2L;
Body Material: SUS304
Power: 1.885-2.243 kw;
Voltage: 220V/50-60Hz
Output: 13L/H;
N.W.: 6.76kg;
G.W.: 7.7kg;
Product size: 20.5*38.5*44 cm;
Packing size: 48*26*50.5 cm;



- With two 1.8L glass pots;
- American style coffee machine (Plastic control board) with plastic Filter Basket;
- On/Off switch, Automatic warming function on top layer;
- Dry-run protection;

Product model: DCM-1600
Water tank capacity: 1.8L;
Material: All stainless steel body;
Power: 1600W
Voltage: 220V-240V
Colour: stainless steel&black;
N.W.: 6.5kg;
G.W.: 6.8kg;
Product size: 21.5*38.5*46 cm;
Packing size: 43.8*22.5*50.2 cm;



Product model: IT-ND1002
Voltage: 220V-240V
Power: 1600W;
Brewing time: 6 - 7 minutes;
Body: 304# S/S;
N.W.: 7kg;
G.W.: 7.8kg;
Water tank capacity: 1.8L
Product size: 21.5*38.5*52 cm;
Packing size: 43*25*57 cm;



Product model: DCM-0001
Voltage: 220V/50Hz;
Power: 1900W;
Out put: 1.8L/5min;
Body: 304# S/S;
N.W.: 6.4kg;
G.W.: 7.6kg;
Water tank capacity: 2.5L
Capacity Of Kettle: 2.2L
Product size: 20.5*38.5*60 cm;
Packing size: 24.5*42.5*63.5 cm;



Product model: DCA-0001
Voltage: 220V/50Hz;
Power: 1812-2156W;
Out put: 16.8L/H;
Body: SUS304;
N.W.: 7kg;
G.W.: 9kg;
Water tank capacity: 2.2L
Capacity Of Kettle: 2L
Product size: 19.5*36.5*55.5 cm;



DISTILLING COFFEE MACHINE

Product model: DCM-288
 Water tank capacity: 2L;
 Body Material: SUS304;
 N.W.: 6.76kg;
 Dimension: 20.5*38.3*44 cm;

Power: 1.885-2.243 kw;
 Voltage: 220V/50-60Hz;
 Output: 13L/H;
 G.W.: 7.7kg;
 Packing size: 48*26*50.5 cm;



- Features:**
- Plastic water inlet;
 - With two 1.8L glass pots;
 - Stainless steel funnel;
 - 304 stainless steel;
 - With 2 glass jugs imported from BUNN USA;



DISTILLING COFFEE MACHINE

Product model: DCA-0001
 Water tank capacity: 2.2L;
 Body Material: SUS304;
 Quantity Of Airpot: 1
 N.W.: 7.0kg;
 Dimension: 19.5*36.5*55.5 cm;

Power: 1812-2156W;
 Voltage: 220V-240V, 50-60Hz;
 Output: 16.8L/H (140 Cups);
 G.W.: 9.0kg;
 Capacity Of Airpot: 2L



- Features:**
- Stainless steel body and brew chamber;
 - Brewing timer: 7 minutes/jug;
 - Brewing indicator;
 - Triple safety protection* without warming plate;
 - De-line remind function;
 - Capacity: 2.2L with thermos 2.0L of air pot x1 pc;



2L CAPACITY
140 CUPS PER HOUR



DISTILLING COFFEE MACHINE

Product model: DCM-0001
 Power: 1900W; Voltage: 220V/50Hz;
 Out put: 1.8L/5min; Body: 304# S/S;
 N.W.: 6.4kg; G.W.: 7.6kg;
 Water tank capacity: 2.5L
 Capacity Of Kettle: 2.2L
 Dimension: 20.5*38.5*60 cm;
 Packing size: 24.5*42.5*63.5 cm;



DISTILLING COFFEE MACHINE

Product model: DCM-1600
 Glass pot volume: 1.8L;
 Power: 1600W; Voltage: 220V-240V;
 N.W.: 6.5kg; G.W.: 6.8kg;
 Material: All stainless steel body;
 Colour: stainless steel&black;
 Product size: 21.5*38.7*46 cm;
 Packing size: 43.8*22.5*50.2 cm;



ELETRONIC COFFEE SCALE

EK2932R

PRODUCT FEATURE

- Mini size, easy to store and carry around
- High precision: division 0.1g for the whole weight range
- Removable, water-proof, anti-skip, anti-scratch and heat insulated silicone mat
- 3 hours fully charged, 28 days endurance
- 2 timing modes available: Manual or auto timing mod
- To show powder to water ratio and flow rate
- With or without button sound



Model	EK2932R
Power supply	3.7V, 450mAh (Built-in rechargeable battery)
Dimension	165*127*310mm
N.W.	4.8KG
Packing size	395*270*190mm
G.W.	6.7KG
LED digit height	8mm
Capacity	2KG/4.4lb
Division	0.1g/0.005oz



- Silicone Mat



ELECTRONIC COFFEE DOSING CUP SCALE



Automatic shutdown time settings
Short pressing as a choice,
long press as confirmation



Double-click to close the sound

IT-DCS



Easy to use



High sensitivity



Multiple uses



Applicable to
58mm handle



Applicable to
58mm handle



Type-C interface
charging cable

Model	IT-DCS
N.W.	134g
Dimension	84*70*78mm
Cup capacity	45ml
Battery	Type-C interface charging cable



● Silver ● Black

IT-DCS-2



Easy to use



High sensitivity



Multiple uses

Model	IT-DCS-2
Dimension	81*80*95mm
Cup capacity	45g
Material	ABS+Silicone+SS304 500mAh
Battery	Type C charging port
Battery capacity	500mAh



ELECTRONIC COFFEE SCALE

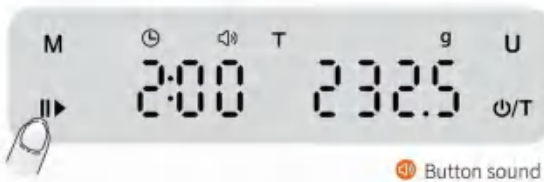

Button sound

IT-CS-22



6.6lb



Division 0.1g
(0.005 oz)



- Type-C charging port
- With built-in rechargeable battery, 3.7V, 300mAh.
- 3 hours fully charged, 30 days endurance (use once a day, 10 minutes / time)

• 2 timing modes available

- Auto timing mode
- Manual timing mode

Model	IT-CS-22
N.W.	4.6KG
Dimension	170*130*28mm
G.W.	6.3KG
Color box size	205*148*42mm
Packing size	310*217*280mm



Button sound

Timing Weighing

IT-CS-21



6.6lb



Division 0.1g
(0.005 oz)



LED digits
16mm



Rechargeable
battery(3.7V)



Indicators



- Type-C charging port
- With built-in rechargeable battery, 3.7V, 400mAh.
- 3 hours fully charged, 22 days endurance (use once a day, 10 minutes / time)

• 2 timing modes available

- Auto timing mode
- Manual timing mode

Model	IT-CS-21
N.W.	5.2KG
Dimension	175*141*32mm
G.W.	7.6KG
Color box size	207*159*44mm
Packing size	340*220*295mm



ELECTRONIC COFFEE SCALE

IT-CS-BK8



- LED Display
- Type C charging
- Automatic tare
- Accurate timer
- High Precision
- Sound switch



• Separate display sections, conspicuous for Time, Ratio and Weight

Model	IT-CS-BK8
Power	3.7v/1000mAh (rechargeable lithium battery)
Dimension	130*150*23.5mm
LED size	79*29mm(A) / 73*15mm(B)
Capacity	2000g / 0.1g
Unit	g/oz/ml
Material	Plastic + Silicone cover

IT-CS-BK2



- LED Display
- Type C charging
- Automatic tare
- Accurate timer
- High Precision
- Sound switch

Model	IT-CS-BK2
Power	3.7v/1000mAh (rechargeable lithium battery)
Dimension	130*150*23.5mm
LED size	79*29mm(A) / 73*15mm(B)
Capacity	2000g / 0.1g
Unit	g/oz/ml
Material	Plastic + Silicone cover

IT-CS-LS1



- LED Display
- Type C charging
- Accurate timer
- High Precision
- Sound switch

Model	IT-CS-LS1
Power	3.7v (Lithium battery)
N.W.	166g
Dimension	130*150*23.5mm
G.W.	479g
Packing size	420*342*170mm
Capacity	2000g / 0.3g
Unit	g/oz/ml
Material	Aluminum alloy body material





IT-OS1-L

BLUETOOTH COFFEE SCALE

- The watch head has adsorption function
- Header independent display
- Freely set the display area



MORE ANGLES



Model	IT-OS1-L
Indexing value	0.1g
Power mode	USB charging/plug-in
Key function	Switch/clear/timing
Error margin	±0.5g
Product Size	152*130*30mm
N.W.	11kg



ESPRESSO DISTRIBUTOR



IT-FCCD10



Model	IT-FCCD10
N.W.	60g
Dimension	87 * 77mm
Specifications	54/58mm



IT-NCD58



Model	IT-NCD58
Specifications	58mm





COFFEE APPLIANCE SET



■ White ■ Black





COFFEE UTENSILS SERIES

COFFEE DISTRIBUTOR DIMENSION:51MM/53MM/58MM

METAL MODLE



WOODEN MODLE



COFFEE DISTRIBUTOR DIMENSION:51MM/53MM/58MM



**COFFEE TAMPERS
DIMENSION:51MM/53MM/58MM**

WOODEN TAMPER



METAL TAMPER



**FIXED RPESSURE MODEL
DIMENSION:51MM/53MM/58MM**

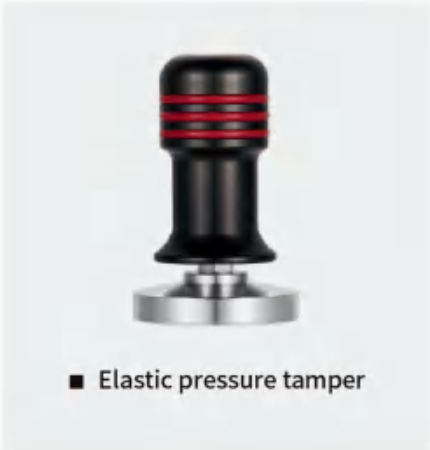

COFFEE TAMPERS DIMENSION: 53MM/58MM

SANDALWOOD SET



■ Wooden tamper



■ Wooden tamper



■ Wooden tamper



■ Wooden tamper

COLOR WOOD SET



■ Wooden tamper



■ Wooden tamper



■ Wooden tamper



■ Wooden tamper

COLOR WOOD SET



■ Wooden tamper



■ Wooden tamper



■ Wooden tamper



■ Wooden tamper



Precision filter



Effective extraction



Easy to clean



Comfortable handshake



304 stainless steel



Free disassembly





COFFEE UTENSILS SERIES

COFFEE FILTER HANDLE DIMENSION:51MM



■ 2 ears,Bottomless



■ 3 ears,Bottomless



■ 3 ears,Bottomless



■ 3 ears,Bottom



■ 3 ears,Bottom



■ 2 ears,Bottomless



■ 3 ears,Bottomless



■ 3 ears,Bottomless

CAN MATCH THE BRAND



COFFEE FILTER HANDLE DIMENSION:54MM



■ 3 ears,Bottom



■ 3 ears,Bottomless



■ 3 ears,Bottomless



■ 3 ears,Bottomless

CAN MATCH THE BRAND



COFFEE FILTER HANDLE DIMENSION:58MM



■ 3 ears



■ 2 ears



■ 2 ears



■ 2 ears, Bottomless



■ 2 ears, Bottomless



■ 2 ears,
Single mouth / double mouth
Bottom



■ 2 ears,
Single mouth / double mouth
Bottom



■ 2 ears, Bottomless



■ 3 ears, Bottomless



■ 2 ears, Bottomless



■ 2 ears, Bottomless



■ Three-in-one



■ Oblique ears
double mouth
Bottom

CAN MATCH THE BRAND

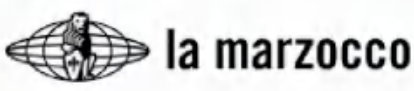

COFFEE KNOCK BOX



B -type slag barrel

Black/primary color



B model aluminum alloy slag barrel

Black/primary color



Stainless steel scum barrel

Large/Small



Silicone Bring Box

Black/primary color



Plastic slag barrel

Black



Square stainless steel residue barrel

High/Dwarf



New-square slag barrel

Black



Inlaid bottomless box

Black



Silicone Bring Box

Large/Small
Black



Drawer slag box

Primary colors/white



Tipping black-drawer dregs box

Large/Small



**Multi -function stitching
solid wood residue box**



Embedded rectangular black slag box



SERIES COFFEE TAMPER SEAT

PLASTIC MODEL



- Stainless steel tamper seat
- Coffee ■ Black



- Plastic tamper seat
- White ■ Black



- Silicone tamper seat
- Coffee ■ Black

WOODEN MODEL



METAL MODEL



- Aluminum
- Black ■ Grey

PRODUCT FEATURE

- Coffee powder
- Appliance storage
- Anti -slip and anti -scratch



EMBEDDED WASH CUP DEVICE

METAL MODLE



■ Large round hole cup device



■ Large long hole washing cup device



■ Square Wash cup Device



■ Mid -number round hole cup device



■ Small round hole cup device

PRODUCT FEATURE

- Stainless steel
- Disclosure ,convenient cleaning
- Energy -saving



Strong water pillar mouth, multi -angle eruption design



Stainless steel drainage drainage slot



Entry and exit water connection at the bottom





COFFEE HANDWRITTEN POT



Xiaoman waist hand in the pot
350ml/600ml
Silver black/rice white/pink/blue



304 stainless steel long mouth drip filter pot
Primary color/white/iron flopon black



Yanzui hand -handed coffee pot
Pink/Tieflon Black



Hand -punching ear pot
250ml/350ml
Color/primary color/titanium/
gun black/iron flopon black



Japanese stainless steel cloud pot
1.0L
Iron Flosion Black

COFFEE HAND -RACK FILTER CUP



A model Solid wood hand punching rack
Black/Copper color



B model Solid wood hand punching rack
Black/Copper color



Love pond cup
Large/Small





COFFEE PULLING CUP



A model pull cup

350ml/600ml

Colorful/titanium blue/primary color/
gun black/rose red/mint green/lemon yellow



B model pull cup

450ml/600ml

Sand rice white/Rus blue/
gun black/color/colorful



C model Internal scale pulling cup

350ml/600ml

Primary color/titanium blue/colorful/
titanium gold/gun black/TMOPLD black



Italian big belly milk cylinder

350ml/500ml

Color/primary colors/sand rice white/
TMOPLen black black



Diagonal mouth pulling cup



PRODUCT FEATURE



304
stainless steel



Colorful



Easy to clean



Durable



Two specifications
optional



Pointed
mouth design



Carefully design
the handle





COFFEE UTENSILS SERIES

COFFEE FILTER HANDLE GIFT BOX



SIMONELLI
■ Gift Box



■ Gift Box



la marzocco
■ Gift Box



■ Gift Box



WPM
■ Gift Box



WPM
■ Gift Box



WPM
■ Gift Box



ROCKET ESPRESSO MILANO **EXOPBAR**
■ Gift Box



Peacock Hand ground coffee gift box

Product name	Coffee grinder	Kettle(600ml)	Filter cup	Filter holder	Sharing kettle (600ml)	Filter paper (40 sheets)
Material	Space Aluminum +420 titanium core + acid branch wood	304, 1.0m + Noble wood	Gopeng glass	Sour wood branch	Gopeng glass	Wood pulp
Product size(mm)	155*50*138	245*103*135	φ114*100	106*10(φ55)	130*106*115	140*102
Inner packing	Black gift Box: 28 * 40 * 15					
Inner box size(cm)	Bag: 41 * 30 * 15.8					
Outer package size(cm)	62*46*42					
G.W./N.W.	15KG/8.2KG					



Swallow Hand ground coffee gift box

Product name	Coffee grinder	Kettle	Filter cup	Filter holder	Sharing kettle	Filter paper
Material	Space Aluminum +420 titanium core + acid branch wood	304, 1.0m + color Wooden handle	Gopeng glass	Sour wood branch	Gopeng glass	Wood pulp
Product size(mm)	155*50*138	245*90*140	φ114*100	106*10(φ55)	130*106*115	140*102
Inner packing	Black gift Box					
Inner box size(cm)	Black gift Box: 28 * 40 * 15			Bag: 41 * 30 * 15.8		
Outer package size(cm)	62*46*42					
G.W./N.W.	15KG/8KG					



Outdoor Set (White)



Outdoor Set (Black)



Klein blue Set

Product name	Outdoor Set (White)	Outdoor Set (Black)	kettle(350ml)	Coffee cup(350ml)	Filter cup	Portable bag
Material	Stainless steel +PU+ cotton rope		304 stainless steel + microfiber leather	304 Stainless Steel + PP	304 stainless steel ABS+PP (Supporting cup)	304 stainless steel
Product size(mm)	215*87*105		165*82*118	85*66*128	72*92	240*220*95
Outer package size(cm)	56*39*51.8		52*29*50.5			
G.W./N.W.	11KG/5KG		Klein blue Set			10KG/8.7KG



≡ About us



Guangzhou Itop Kitchen Equipment Co., Ltd. was founded in 2009, now it developed into a set R&D, inspection, production, marketing in one group company which owns many international known Commercial Kitchen Equipment brands and its core advantages.

Who are we?

We are a manufacturer and trader with rich experience in the Commercial Kitchen Equipment industry.

Product

We guarantee that the products provided are of high quality and best durability, high performance and cost efficiency.

Our culture

Our corporate culture has made our products recognized by the whole society and established a reliable and lasting good reputation.

≡ Company strength

Annual Turnover:



BesLock is a ISO9001 certified company. Our products are compliant with following standard:



ITOP Development History



2013

Manufacturing Plant:

ITOP has invested 2 factories :

- 1) Western food equipment Factory in Guangzhou.
- 2) Coffee machine Factory In Zhaoqin City.

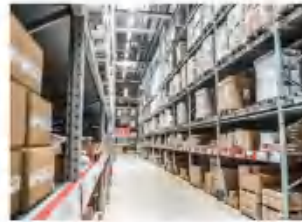

- 1) R&D Department Built In,
 - 2) Warehouse In London, Moscow, Prague ,Sydney, Los Angeles, Frankfurt,Dubai,Saudi Arabia
- We can match our Distributors demand



2021

2016



Kitchen Project Solution
Kitchen Design:
——Help our Distributors not only buy & sell



Brand Story

Our founders, Jane Cheung and Edmond Wong, had the luck to work in the same Macdonald' s while they took their summer jobs as college students. Edmond was always the first who came to the store and the last who left the store so that he could spend more time with Jane. He also tried to get accustomed to the workflow and the catering equipment, so that he would be able to teach Jane. Time went by quickly, and more than a month later, Edmond fell in love with Jane, and Jane also had a fancy for Edmond. Then, embarking on different paths of education and career, they went to different cities to work and live.

Years passed. At a casual meeting, Edmond found that he was still in love with Jane.

Only this time, he was not going to let go of his dream girl. What should he do? He needed a stage to show himself.

Edmond learnt that there would be a catering equipment show in Guangzhou. He did a lot of research, visited the largest local commercial kitchen market, and made a business plan.

He then invited Jane to the show together. He told her about her business plan. Although it was not a perfect plan according to mature business standards, thinking of her experience with Edmond in that summer job, Jane felt Edmond was a reliable man and also saw the convenience commercial catering could bring to fast-paced city life. They started a business and got married, giving birth to two lovely daughters Dora and Lyn.





After making many errors and corrections, and thanks to their sharp sense of the market and continuous optimization of the products, they have expanded their original export team of two to today' s nearly thirty members and owned a workshop of over 2,000 m2 in Zhaoqing, Guangdong. They have developed their products with certificates and patents, and have their own brand in Europe and America. They also have overseas warehouses in major markets in Europe, America, Dubai, and Australia to quickly respond to customer orders.

Our Itop company focuses on niche markets, such as commercial coffee series, and blender with sound insulation, which can create a better customer experience for open coffee shops.

We also have commercial kitchen solutions and scene design, allowing customers to see what they will get by means of 3D drawings and VR. Edmond and Jane are greatly honored to be able to bring cost-effective products made in China to every corner of the earth through commercial catering equipment and thus contribute their share to making the world a better place.

Section 1: Commercial Kitchen Equipment; Bakery Equipment; Refrigeration

Equipment; Stainless Steel Goods

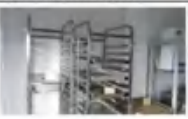
1.1 The Competitive Advantage of Product Line				
The company can accepted ODM & OEM services.				
1.2 Product Line Description				
Commercial Kitchen Equipment; Bakery Equipment; Refrigeration Equipment; Stainless Steel Goods				
Product Sample				
1. Commercial Kitchen Equipment	2. Commercial Kitchen Equipment			
				
3. Commercial Kitchen Equipment				
4. Bakery Equipment	5. Refrigeration Equipment			
				
6. Stainless Steel Goods				
1.3 Production Capacity				
Production Line Capacity	Actual Units Produced (Previous 12 months)			
Commercial Kitchen Equipment: 2,000 Pcs / Month, Bakery Equipment: 3,500 Pcs / Month, Refrigeration Equipment: 500 Pcs / Month, Stainless Steel Goods: 3,000 Pcs / Month	Confidential			
Number of Product Categories	Number of Product Models			
100	600			
1.4 Production Machinery				
Machine Name	Brand & Model No.	Quantity	Number of Year(s) Used	Condition
Cutting Machine	ACL	20	3	Acceptable
Laser Cutting Machine	DNE 1530	4	3	Acceptable
CNC Punch Pressing Machine	YAWEI	3	3	Acceptable
Report No.: 22099777_P+T	Report Date: 02/Jul/2021	Assessed By: Victor Du	Page No: 5 of 8	
CONFIDENTIAL	All Rights Reserved			

Section 8: Certification & Photos

Certification & Photos			
Certification & Photos -- Business License (Original)	Certification & Photos -- Business License (Duplicate) with Certificate / Records of Annual Inspection		
			
Certification & Photos -- Permit for Opening Bank Account	Certification & Photos -- Custom Clearance Registration Form		
			
Certification & Photos -- Import and Export Enterprise Registration	N/A		
	N/A		
Report No.: 22099776_T	Report date: 02/Jul/2021	Assessed By: Victor Du	Page No: 15 of 21
CONFIDENTIAL	All Rights Reserved		

≡ We would like to promise you:

100% refund if quality not as promised.



100% replacement or refund if any defective



100% refund if we missed your Event date.



5 new models can be ready each month, we can supply you free samples.



Amazing hot sales product



Ver 2026.02.05

13th Anniversary for Itop



[HTTPS://www.itopcafe.com/](https://www.itopcafe.com/)

TEL : +86-20-34619349

Whatsapp : +86 189 0228 6006

Facebook : itopkitchen

E-MAIL : export@itopkitchen.cn

Add:Duoyuan Business Center, No. 48,
Guangchang West Road, Shiqiao Street, Panyu District, Guangzhou City.